

SIEMENS

SIWAREX[®] CS

Device Manual

Status 06/2011



Warning and Safety Terms

This manual contains notices that are for your personal safety and to prevent damage to devices or surroundings. These notices are indicated by a warning triangle and are presented as follows depending on the degree of danger:



Danger

Means that failure to take the necessary safety precautions **will** result in death, serious injury and/or considerable property damage.



Warning

Means that death, severe injury or serious material damage **can** result if the corresponding safety precautions are not followed carefully.



Caution

Means that material damage or minor injuries can result if the corresponding safety precautions are not followed carefully.

Caution

Means that material damage can result if the corresponding safety precautions are not followed carefully.

Attention

Refers to important information on the product, handling of a product or a corresponding segment of the documentation to which special attention should be given.

Qualified Personnel

Commissioning and operation of a device may only be performed by **qualified personnel**. Qualified personnel in a technical safety sense within this manual are personnel that have the qualifications for installing, grounding and identifying all devices, systems and circuits in accordance with the applicable technical safety standards.
Intended Utilization



Warning

The device may only be utilized for the applications described in the catalog and the technical description and only in conjunction with external devices and components that are approved or recommended by Siemens.
Fault-free and safe operation of the product depend on proper transport, proper storage, assembly, installation, operation and maintenance.

Brand names / Trademarks

SIWAREX[®], SIMATIC[®], SIMATIC HMI[®] and SIMATIC NET[®] are trade marks of the Siemens AG. The other designations in this info may be trade marks the use of which by third persons for their own purposes might infringe proprietor rights.

Copyright © Siemens AG 2007 All rights reserved

Circulation or duplication of this document, utilization and disclosure of its contents are not permitted unless explicitly approved. Offenders will be liable for damages. All rights reserved, including rights created by granting of patents or registration of a utility model or design.

Siemens AG
Automation & Drives Dept.
SIWAREX Weighing Systems
A&D SC PS1 WT
Östliche Rheinbrückenstr. 50
D-76187 Karlsruhe

Disclaimer

We have tested the contents of this document for compatibility with the hardware and software described. This does not exclude the possibility of discrepancies, in which case we do not guarantee the complete compatibility of this document. The information in this document is assessed regularly and any necessary corrections are included in the next revision.
We are grateful for any suggestions for improvement.

© Siemens AG 2007
Subject to change without notice.

SIWAREX CS

Weighing Electronics for ET 200S

Device Manual

Issue 06/2011

<u>Warning and Safety Terms</u>	
<u>Contents</u>	
Preface	1
Scope of Delivery	2
Product Overview	3
Hardware Configuration and Assembly	4
Weighing Functions	5
Commands	6
Messages and Diagnosis	7
Programming in SIMATIC STEP 7	8
Setting the Scale – SIWATOOL CS	9
Calibrating Applications	10
Accessories	11
Technical Data	12
Index	13
Abbreviations	14

Contents

1 Preface	1-1
1.1 PURPOSE OF MANUAL	1-1
1.2 BASIC KNOWLEDGE REQUIRED	1-1
1.3 SCOPE OF MANUAL	1-1
1.4 FURTHER SUPPORT	1-3
2 Scope of Delivery	2-4
2.1 SCOPE OF DELIVERY	2-4
2.2 REQUIRED HEAD MODULES FOR SIWAREX CS	2-4
2.3 REQUIRED PLC CONTROLLERS FOR SIWAREX CS	2-5
3 Product Overview	3-6
3.1 GENERAL	3-6
3.2 AREA OF APPLICATION	3-7
3.3 STRUCTURE	3-7
3.4 FUNCTION	3-8
3.5 SYSTEM INTEGRATION IN SIMATIC	3-8
3.6 SCALE ADJUSTMENT WITH SIWATOOL CS	3-9
4 Hardware Configuration and Assembly	4-11
4.1 CONFIGURING THE HARDWARE IN SIMATIC	4-12
4.2 STRUCTURE TO EMC GUIDELINES	4-12
4.2.1 Definition: EMC	4-12
4.2.2 Introduction	4-12
4.2.3 Possible Effects of Interference	4-13
4.2.4 Coupling Mechanisms	4-13
4.2.5 Five Basic Rules for Guaranteeing EMC	4-13
4.3 ASSEMBLY	4-15
4.4 CONNECTION AND WIRING	4-15
4.4.1 Connection Areas for SIWAREX CS	4-15
4.4.2 Shielding connection	4-16
4.4.3 Connection of 24 V Power Supply	4-17
4.4.4 Connections to Terminal Module	4-17
4.4.5 Load Cell Connection	4-17
4.4.6 Connecting the Siebert Remote Display	4-20
4.4.7 Connecting the PC for SIWATOOL CS	4-20
4.4.8 LED Display Elements	4-21
4.5 PREPARING FOR OPERATION	4-22
4.6 USE FOR POTENTIALLY EXPLOSIVE AREA	4-23
5 Weighing Functions	5-25
5.1 GENERAL	5-25
5.2 DS3 ADJUSTMENT PARAMETER	5-25
5.2.1 DS3 – Adjustment digits 0, 1, 2, for zero point and adjustment weights 1, 2	5-27
5.2.2 DS3 – Characteristic Value Range	5-30
5.2.3 DS3 – Low Pass Filter	5-30
5.2.4 DS3 – Limit Frequency	5-31
5.2.5 DS3 – Depth of Average Value Filter	5-31
5.2.6 DS3 – Scale Name	5-31
5.2.7 DS3 – Minimum Weight for Weighing Range	5-31
5.2.8 DS3 – Weighing Range	5-31
5.2.9 DS3 – Numeral Step for Weighing Range	5-31
5.2.10 DS3 – Standstill time	5-31
5.2.11 DS3 – Standstill Range	5-32
5.2.12 DS3 – Decimal Place for Remote Display and ASCII Weight Output	5-32
5.2.13 DS3 – Maximum Negative Weight for Zero Setting	5-33
5.2.14 DS3 – Maximum Positive Weight for Zero Setting	5-33
5.2.15 DS3 – Tare Max. Weight T-	5-33

5.2.16	<i>DS3 – Regulations</i>	5-33
5.2.17	<i>DS3 – Unit of Measurement</i>	5-33
5.3	DS 4 LIMIT VALUE PARAMETERS	5-33
5.3.1	<i>DS 4 – Switch On Weight, Limit Value 1</i>	5-34
5.3.2	<i>DS 4 – Switch Off Weight, Limit Value 1</i>	5-35
5.3.3	<i>DS 4 – Switch On Weight, Limit Value 2</i>	5-35
5.3.4	<i>DS 4 – Switch Off Weight, Limit Value 2</i>	5-35
5.3.5	<i>DS 4 – Basis Weight for Limit Values</i>	5-35
5.4	DS 9 INFO ON MODULE	5-35
5.5	DS 15 TARE ENTRY	5-36
5.5.1	<i>DS 15 – Tare Entry</i>	5-36
5.6	DS 26 INTERNAL PROCESS VALUES	5-36
5.7	DS 30 PROCESS VALUES	5-37
5.7.1	<i>DS 30 – Scale Status</i>	5-37
5.7.2	<i>DS 30 – Operating Errors</i>	5-38
5.7.3	<i>DS 30 – Gross Process Value</i>	5-38
5.7.4	<i>DS 30 – Net Process Value</i>	5-38
5.7.5	<i>DS 30 – Tare Process Value</i>	5-38
5.7.6	<i>DS 30 – G/N Weight</i>	5-39
5.7.7	<i>DS 30 – G/N Weight_x10</i>	5-39
5.7.8	<i>DS 30 – Tare</i>	5-39
5.7.9	<i>DS 30 – Unfiltered Raw Digit Value from AD Converter</i>	5-39
5.7.10	<i>DS 30 – Filtered Digit Value from AD Converter</i>	5-39
5.7.11	<i>DS 30 – ASCII Weight Value</i>	5-39
5.7.12	<i>DS 30 – Runtime Duration</i>	5-39
6	Commands	6-40
6.1	COMMAND GROUPS	6-40
6.2	COMMAND LIST	6-40
7	Messages and Diagnosis	7-43
7.1	MESSAGE TYPES	7-43
7.2	MESSAGE PATHS	7-43
7.3	DETECTION OF MESSAGES USING SIWATOOL CS	7-44
7.4	DETECTION OF MESSAGES USING FB SICS	7-44
7.5	DETECTION OF MESSAGES USING THE DIAGNOSTIC ALARMS IN THE SIMATIC CPU	7-44
7.6	DETECTION OF MESSAGES USING PROCESS ALARMS	7-44
7.7	LIST OF DATA AND COMMAND MESSAGES (SYNCHRONOUS MESSAGES)	7-45
7.8	MESSAGE LIST FOR OPERATING MESSAGES (ASYNCHRONOUS ERRORS)	7-46
7.9	MESSAGES VIA LEDES	7-48
8	Programming in SIMATIC STEP 7	8-49
8.1	GENERAL	8-49
8.2	PERFORMANCE DIFFERENCES WITH DIFFERENT HEAD MODULES	8-49
8.2.1	<i>Communication</i>	8-49
8.2.2	<i>Alarm Functions</i>	8-49
8.3	SIWAREX CS IN HW CONFIG	8-50
8.4	SIWAREX CS IN CYCLIC STEP 7 PROGRAM	8-50
8.4.1	<i>SICS_BA for Basic Head</i>	8-50
8.4.2	<i>SICS_DR for the Standard Head, the High Feature Head and CPU Head</i>	8-50
8.4.3	<i>FB SICS... Call</i>	8-50
8.5	CALL PARAMETERS FOR FB SICS	8-51
8.5.1	<i>ADDR:= 256. Input, INT</i>	8-51
8.5.2	<i>DB_SCALE:= 21 or 22, Input, INT</i>	8-52
8.5.3	<i>DB_VECTOR:= 20, Input, INT</i>	8-52
8.5.4	<i>CMD_IN:= "DB_SCALE".i_CMD_INPUT, Input, INT</i>	8-52
8.5.5	<i>EXT_TARA:= "DB_SCALE_CS".i_PRESET_TARE, Input, INT</i>	8-52
8.5.6	<i>SELECT_PROC_VAL:= "DB_SCALE".b_SELECT_PROC_VAL, Input, BYTE</i>	8-52

8.5.7	<i>CMD_INPR:= "DB_SCALE".bo_CMD_IN_PROGRESS, Output, BOOL</i>	8-52
8.5.8	<i>CMD_FOK:= "DB_SCALE".bo_CMD_FINISHED_OK, Output, BOOL</i>	8-53
8.5.9	<i>CMD_ERR:= "DB_SCALE".bo_CMD_ERR, Output, BOOL</i>	8-53
8.5.10	<i>CMD_ERR_C:= "DB_SCALE".b_CMD_ERR_CODE, Output, BYTE</i>	8-53
8.5.11	<i>REF_COUNT:= "DB_SCALE".b_INFO_REFRESH_COUNT, Output, BYTE</i>	8-53
8.5.12	<i>ACT_SEL_PROC_VAL:= "DB_SCALE".b_SELECTED_PROC_VAL, Output, BYTE</i> ..	8-53
8.5.13	<i>PROC_VALI:= "DB_SCALE".i_PROCESS_VALUE, Output, INT</i>	8-53
8.5.14	<i>SC_STATUS:= "DB_SCALE".w_SCALE_STATUS, Output, BYTE</i>	8-53
8.5.15	<i>ERR_MSG_C:= "DB_SCALE".b_OPR_ERR_MSG, Output, BYTE</i>	8-53
8.5.16	<i>FB_ERR:= "DB_SCALE".bo_FB_ERR, Output, BOOL</i>	8-53
8.5.17	<i>FB_ERR_C:= "DB_SCALE".b_FB_ERR_CODE, Output, BYTE</i>	8-54
8.5.18	<i>START_UP:= "DB_SCALE".bo_START_UP_IN_PROGRESS, Output, BOOL</i>	8-54
8.5.19	<i>CMD_EN:= "DB_SCALE".bo_CMD_ENABLE, Input, BOOL</i>	8-54
8.6	ALLOCATION OF SCALE DB	8-55
9	Setting the Scale – SIWATOOL CS	9-60
9.1	GENERAL	9-60
9.2	WINDOWS AND FUNCTIONS IN SIWATOOL CS	9-60
9.3	OFFLINE CONFIGURATION	9-60
9.4	ONLINE OPERATION	9-60
9.5	HELP	9-61
10	Calibrating Applications	10-62
10.1	GENERAL INFORMATION	10-62
10.2	SEALING IN CALIBRATING APPLICATION.....	10-63
11	Accessories	11-66
12	Technical Data	12-69
12.1	POWER SUPPLY 24 V	12-69
12.2	POWER SUPPLY FROM ET 200S BACKPLANE BUS	12-69
12.3	LOAD CELL CONNECTION	12-69
12.4	RS 232C INTERFACE	12-70
12.5	TTY INTERFACE.....	12-70
12.6	DIMENSIONS AND WEIGHT	12-70
12.7	AMBIENT CONDITIONS	12-71
12.8	MECHANICAL REQUIREMENTS AND DATA	12-71
12.9	ELECTRICAL, EMC AND CLIMATIC REQUIREMENTS	12-72
12.9.1	<i>Electrical Protection and Safety Requirements</i>	12-72
12.9.2	<i>Electromagnetic Compatibility</i>	12-73
12.9.3	<i>Climatic Requirements</i>	12-74
13	Index	13-76
14	Abbreviations	14-78

Illustrations

FIGURE 3-1	SYSTEM OVERVIEW	3-7
FIGURE 3-2	AREAS OF APPLICATION FOR SIWAREX IN THE PRODUCTION CHAIN	3-8
FIGURE 3-3	TYPICAL CONFIGURATION OF SIMATIC S7 WITH SIWAREX CS	3-9
FIGURE 3-4	SIWATOOL CS OVERVIEW	3-10
FIGURE 4-1	SIWAREX CS CONNECTION AREAS	4-15
FIGURE 4-2	ASSEMBLY OF SHIELD CLAMPS.....	4-16
FIGURE 4-3	LOAD CELL CONNECTION WITH 4-WIRE SYSTEM.....	4-19
FIGURE 4-4	LOAD CELL CONNECTION WITH 6-WIRE SYSTEM.....	4-19
FIGURE 4-5	CONNECTING THE S102 DISPLAY.....	4-20
FIGURE 4-6	CONNECTING THE PC.....	4-21
FIGURE 5-1	ADJUSTMENT DIGITS AND WEIGHT VALUE	5-28
FIGURE 5-2	LINEARIZATION OF SCALE CHARACTERISTIC CURVE	5-29
FIGURE 5-3	STEP RESPONSE OF DIGITAL LOW PASS FILTER AT FG = 2 HZ.....	5-30

FIGURE 5-4	STANDSTILL MONITORING	5-32
FIGURE 5-5	PARAMETERIZATION OF LIMIT VALUES	5-35
FIGURE 8-1	CALL PARAMETERS FOR FB SICS_BA	8-51
FIGURE 8-2	CALL PARAMETERS FOR FB SICS_DR	8-51
FIGURE 9-1	SIWATOOL CS WINDOW ASSIGNMENT	9-61
FIGURE 10-1	TERMINAL COVER IN CALIBRATING APPLICATION	10-64
FIGURE 10-2	IDENTIFICATION PLATE, CALIBRATION MARK AND SECURITY LABELS. .	10-

65

Tables

TABLE 1-1	SCOPE OF MANUAL	1-1
TABLE 1-2	OVERVIEW OF CHAPTER.....	1-2
TABLE 4-1	REQUIREMENTS FOR N SIWAREX CS MODULES.....	4-12
TABLE 4-2	LOAD CELL CONNECTION	4-18
TABLE 4-3	CONNECTING THE PC.....	4-20
TABLE 4-4	DISPLAY ELEMENTS (LED)	4-21
TABLE 5-1	DS3 ALLOCATION	5-27
TABLE 5-2	DS 4 ALLOCATION	5-34
TABLE 5-3	DS 9 ALLOCATION	5-36
TABLE 5-4	DS 15 ALLOCATION	5-36
TABLE 5-5	DS 26 ALLOCATION	5-36
TABLE 5-6	DS 30 ALLOCATION	5-37
TABLE 5-7	STATUS INFORMATION	5-38
TABLE 6-1	SIWAREX CS COMMAND LIST.....	6-42
TABLE 6-2	SIWAREX CSCOMMAND GROUPS	6-42
TABLE 7-1	LIST OF DATA AND OPERATING ERRORS	7-46
TABLE 7-2	LIST OF OPERATING MESSAGES	7-47
TABLE 7-3	ERROR BYTE FOR OPERATING MESSAGES	7-47
TABLE 7-4	LIST OF LED MESSAGES	7-48
TABLE 8-1	ALLOCATION OF SCALE DB FOR FB SICS_DR.....	8-58
TABLE 8-2	ALLOCATION OF SCALE DB FOR FB SICS_BA	8-59
TABLE 12-1	DATA: POWER SUPPLY 24 V	12-69
TABLE 12-2	DATA: POWER SUPPLY FROM ET 200S BACKPLANE BUS	12-69
TABLE 12-3	DATA: LOAD CELL CONNECTION	12-70
TABLE 12-4	DATA: RS 232C INTERFACE.....	12-70
TABLE 12-5	DATA: TTY INTERFACE	12-70
TABLE 12-6	DATA: DIMENSIONS AND WEIGHT	12-70
TABLE 12-7	DATA: AMBIENT CONDITIONS.....	12-71
TABLE 12-8	DATA: MECHANICAL REQUIREMENTS.....	12-71
TABLE 12-9	DATA: ELECTRICAL PROTECTION AND SAFETY REQUIREMENTS.....	12-73
TABLE 12-10	DATA: ELECTROMAGNETIC COMPATIBILITY	12-74
TABLE 12-11	DATA: CLIMATIC REQUIREMENTS	12-75

1 Preface

1.1 Purpose of Manual

This manual contains all the information required to set up and operate the SIWAREX CS.

1.2 Basic Knowledge Required

To understand this manual, general knowledge in the area of SIMATIC automation technology is required. Knowledge of weighing technology is an advantage.

1.3 Scope of Manual

This manual applies to the SIWAREX CS module:

Type	Name	Order number	From product revision (Version)	
SIWAREX CS	SIWAREX Compact Scale	7MH4910-0AA01	HW 3	FW V.1.4

Table 1-1 Scope of Manual

Note

This manual describes the SIWAREX CS weighing electronics as part of the SIMATIC ET 200S system and should be used as a supplement to the manual for the ET 200S.

Note

This manual contains a description of the module that is valid at the time of publication.

We reserve the right to supply new modules or newer versions of modules with product documentation containing current information about the module.

The layout of this manual is based on activities that must be performed as part of configuration, commissioning, operation and service / maintenance.

Chapter	Description of Content
<i>1 Preface</i>	Notes on using this manual
<i>2 Scope of Delivery</i>	Description of the SIWAREX CS scope of delivery
<i>3 Preface</i>	Overview of -Structure - Functionality - System integration of SIWAREX CS.
<i>4 Hardware Configuration and Assembly</i>	Description - of individual hardware components - of structure and installation - of connections - of preparations for operation.
<i>5 Weighing Functions</i>	Description of all weighing parameters and corresponding functions.
<i>6 Commands</i>	Description of commands that can be executed by SIWAREX CS.
<i>7 Messages and Diagnosis</i>	Description of messages with notes on problem resolution.
<i>8 Programming in SIMATIC STEP 7</i>	Description of data exchange with SIMATIC CPU. This chapter is aimed at those who are writing application software.
<i>9 Setting the Scale – SIWATOOL CS</i>	Description - Software installation - Software functions
<i>10 Calibrating Applications</i>	Description of conditions for calibration
<i>11 Accessories</i>	Ordering information for optional components such as: - Remote digital displays - Ex interface - STEP 7 software
<i>12 Technical Data</i>	Technical Data
<i>13 Index</i>	Index
<i>14 Abbreviations</i>	List of Abbreviations

Table 1-2 Overview of Chapter

1.4 Further Support

Do you have any more questions about using the SIWAREX CS? If so, please contact your Siemens representative in the office or business location responsible for your area or the SIWAREX technical support line Tel.: +49 (0)721 595 2811.

Updated information on SIWAREX weighing technology can be found on the relevant Internet site.

<http://www.siemens.com/siwarex>

2 Scope of Delivery

2.1 Scope of Delivery

The scope of delivery of the SIWAREX CS includes the manufacturer's declaration of conformity and a supplementary sheet containing up to date information about the product.

To configure the SIWAREX CS, you will require the SIWAREX CS for SIMATIC S7 configuration package, which must be ordered separately.

The configuration package is made up of the following components:

- The Windows program SIWATOOL CS for adjusting the scale at commissioning
- Software „Getting Started“, it contains the S7 blocks for operating the SIWAREX CS in SIMATIC S7. For the initial programming steps, the "Getting Started" software is also extremely useful. Newer versions may be obtained free of charge on the Internet (www.siemens.com/siwarex).
- Device manuals in several languages

The required and optional accessories are summarized in chapter 11 *.Accessories*.

2.2 Required Head Modules for SIWAREX CS

SIWAREX CS can be used for following head modules:

PROFIBUS	IM 151-1 Basic	6ES7 151-1CA00-0AB0 and later
	ET200S Compact 6DI/16DO	6ES7 151-1CA00-3BL0 and later
	ET200S Compact 32DI	6ES7 151-1CA00-1BL0 and later
	IM151-1 Standard	6ES7 151-1AA02-0AB0 and later
	IM151-1 FO Standard	6ES7 151-1AB02-0AB0 and later
	IM151-1 High Feature	6ES7 151-1BA00-0AB0 and later
PROFIBUS-CPU	IM151-7 CPU FO	6ES7 151-7AB00-0AB0 and later
	IM151-7 CPU	6ES7 151-7AA00-0AB0 Firmware V2.1 and later
PROFIBUS-F-CPU	IM151-7 F-CPU	6ES7 151-7FA00-0AB0 and later
PROFINET	IM151-3 PN Standard	6ES7 151-3AA20-0AB0 and later
	IM151-3 PN High Feature	6ES7 151-3BA20-0AB0 and later
	IM151-3 PN FO	6ES7 151-3BB21-0AB0 and later
PROFINET-CPU	IM151-8 PN/DP CPU	6ES7 151-8AB00-0AB0 and later
PROFINET-F-CPU	IM151-8F PN/DP	6ES7 151-8FB00-0AB0 and later

Step7 offers only limited functionality for Basic and Compact modules and any older standard modules, as they do not allow data record communication (without DP V1); see Section 8 *Programming in SIMATIC STEP 7*

2.3 Required PLC Controllers for SIWAREX CS

SIWAREX CS can be used for following controllers:

- S7-300 CPUs: Firmware 2.x and later
- S7-318 and S7-400 CPUs: Firmware version 3.x and later

3 Product Overview

3.1 General

SIWAREX CS (Compact Scale) is a versatile and flexible weighing module, which can be used wherever static scales are to be used in the ET 200S automation system or a force measurement is necessary.

The SIWAREX CS function module (FM) can be used in SIMATIC ET 200S and takes full advantage of all the features of the modern automation system, including the integrated communication, the diagnostic system and the configuration tools.

The weighing functionality of the SIWAREX CS includes the non-automatic weighing instrument functions in accordance with OIML R-76.

Customer benefits:

SIWAREX CS is characterized by a number of crucial advantages:

- Standardized connection technology and integrated communication due to use in SIMATIC ET 200S
- Standardized configuration using SIMATIC Manager
- Use in a decentralized system concept through connection to PROFIBUS DP via ET 200S
- Weight or force measurement to a high resolution of 16 Bit
- High accuracy 0.05 %
- Calibration 2000 d
- High measuring rate of 50 Hz
- Monitoring of limit values
- Flexible adaptation to different requirements with SIMATIC control
- Easy adjustment of scale using the SIWATOOL CS program via the RS 232 interface
- Theoretical adjustment without adjustment weights
- Exchange of module possible without readjusting scales
- Use in Ex zone 2 / ATEX certification.
- Intrinsically safe load cell power supply for use in zone 1 areas with risk of explosion (SIWAREX IS option)
- Diagnostic functions

3.2 Area of Application

SIWAREX CS is the optimum solution wherever signals from DMS sensors or load cells are to be recorded. As a weighing electronics system, SIWAREX CS offers high accuracy and a calibration rating of 2000d. With a measurement time of 20 ms, the module can also be used as evaluation electronics for force measurement.

SIWAREX CS is optimally equipped for the following applications:

- Filling level monitoring for silos and bunkers
- Measurement of crane and cable loads, other force measurement
- Load measurement for industrial elevators or mill trains
- Weighing in areas with a risk of explosion (with SIWAREX IS Ex interface)
- Belt tensioning measuring equipment

3.3 Structure

SIWAREX CS is a function module (FM) of SIMATIC ET 200S and can be plugged directly into a terminal module. The installation and cabling for the 30 mm wide module is minimal. The load cells, the power supply and the serial interfaces are connected via the terminal module with 16 connection points. Operation of the SIWAREX CS in SIMATIC guarantees complete integration of weighing technology into the automation system.

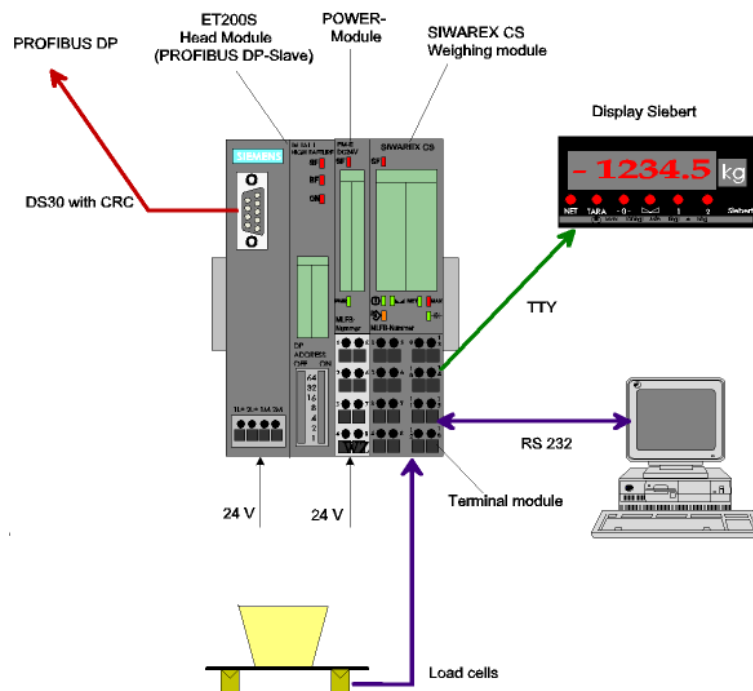

Figure 3-1 System Overview

3.4 Function

The primary task of the SIWAREX CS lies in the measurement of the current weight value. Integration into SIMATIC makes it possible to process the weight value directly in the PLC.

SIWAREX CS is pre-adjusted in the factory. This means that the scale can be adjusted to theoretical settings without using any adjustment weights and modules can be exchanged without readjusting the scale. Modules can be exchanged during operation in ET 200S.

The SIWAREX CS has two serial interfaces. A TTY interface is used for connecting remote digital displays. A PC for adjustment of the SIWAREX CS can be connected to the RS 232 interface.

The SIWAREX CS weighing module can also be used in areas with a risk of explosion (zone 2). An optional Ex interface SIWAREX IS gives load cells an intrinsically safe power supply for applications in zone 1. Further information about use for potentially explosive area you find in chapter 4.6.

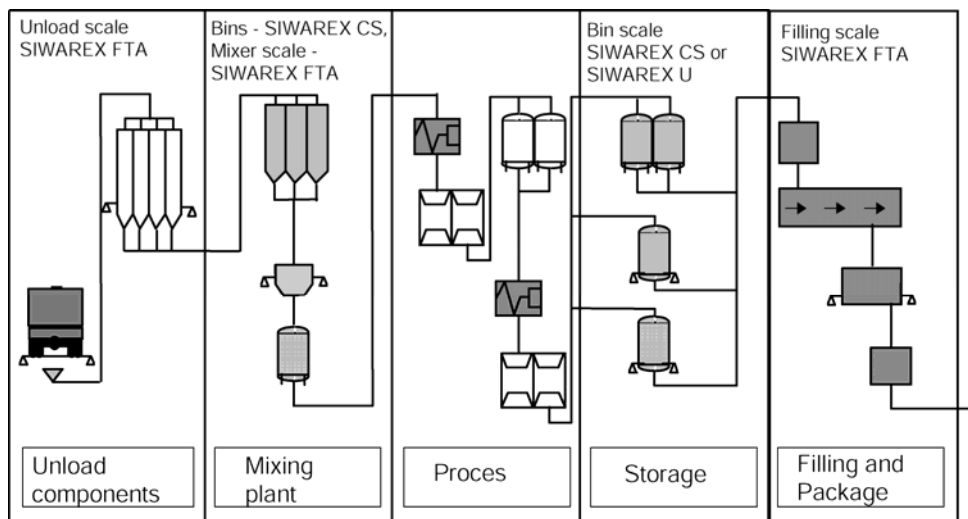

Figure 3-2 Areas of Application for SIWAREX in the Production Chain

3.5 System Integration in SIMATIC

SIWAREX CS is a component of SIMATIC ET 200S. This gives you complete freedom for configuration of the automation solution – including the weighing application. The optimum solution can be created for small, medium and large systems by selectively combining the SIMATIC components. The configuration package and the example applications for SIMATIC can help you to quickly and

2BProduct Overview

efficiently develop customer or industry specific solutions. The following figure shows a typical setup for a medium sized system.

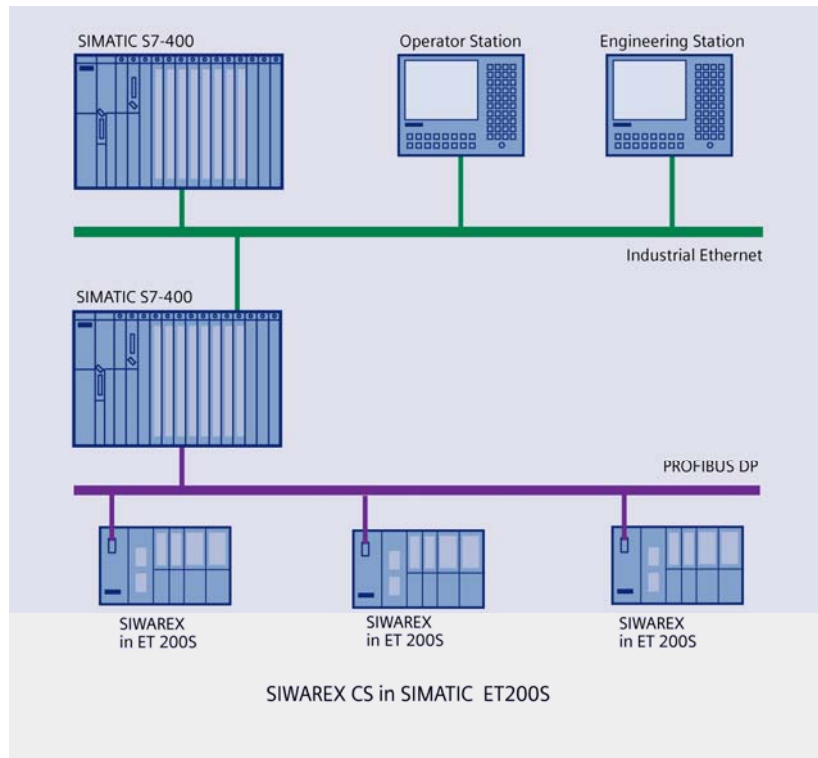

Figure 3-3 Typical Configuration of SIMATIC S7 with SIWAREX CS

3.6 Scale Adjustment with SIWATOOL CS

For adjustment of the scale, there is a special program – SIWATOOL CS for Windows operating systems.

The program enables the scale to be commissioned without having to understand automation technology. During servicing, you can analyze the processes in the scale and test them with the aid of a PC independently of the automation system. Reading the diagnostic buffer from the SIWAREX CS is very helpful in analyzing events.

The following figure shows the structure of the individual program windows.

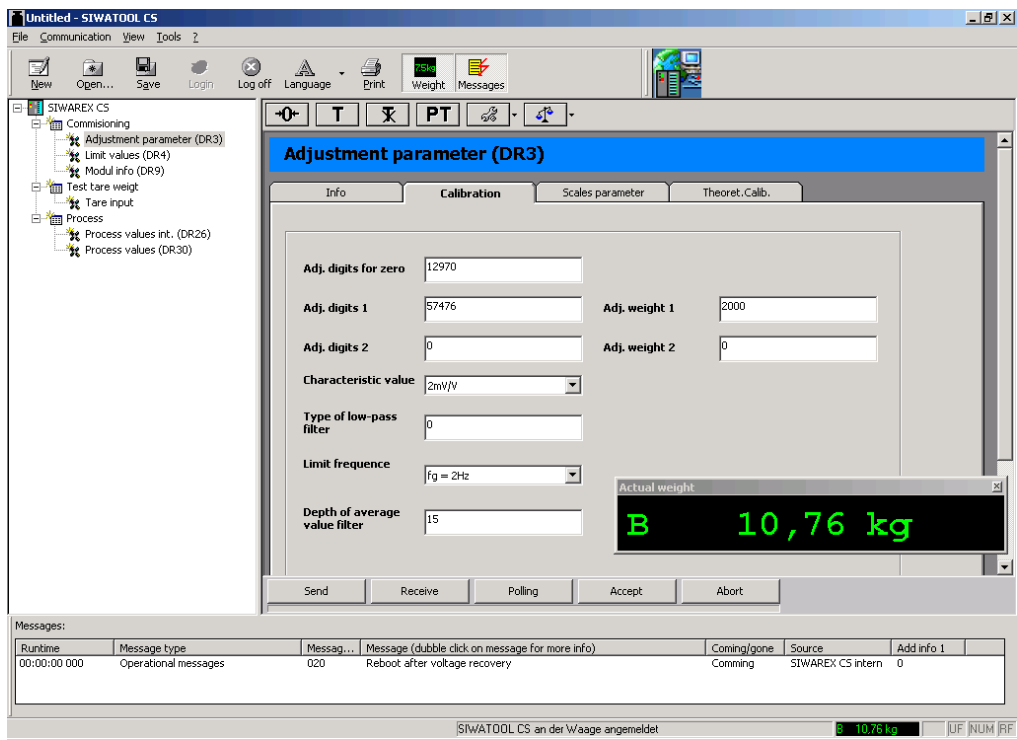

Figure 3-4 SIWATool CS Overview

SIWATool CS does more than support you in adjusting the scale. It is very useful to analyze the diagnostic buffer, the contents of which can be saved along with the parameters after reading from the module.

In the program, you can choose between several languages.

4 Hardware Configuration and Assembly



Warning Notes

For configuration, assembly and commissioning, the definitions from the manual for the ET 200S decentralized peripheral system are applicable. This chapter provides you with additional information for hardware configuration and assembly, and for preparing the SIWAREX CS for operation.

The technical safety information is to be strictly adhered to.



Warning

Unqualified intervention in the device/system or not adhering to the warning notices can result in serious injury or damage to equipment. Only qualified personnel are permitted to access the operational components of this device / system.



Warning

The unit has been developed, manufactured, tested and documented in accordance with the corresponding safety standards. The device itself will not cause any danger to equipment or personal health under normal circumstances.



Danger

Commissioning is not permitted until it is guaranteed that the machine in which these components are to be integrated meets with the guidelines in 89/392/EC.

4.1 Configuring the Hardware in SIMATIC

SIWAREX CS is a function module (FM) in the ET 200S decentralized peripheral automation system. It can be plugged into terminal modules that are designed for double width function modules (see chapter [11 Accessories](#)).

When estimating the maximum number of SIWAREX CS units that can be integrated into one head system, the following information may be helpful.

Number of SIWAREX CS modules = n

Total width	RAM requirements in SIMATIC CPU
n x 30 mm	3750 bytes + n x 312 bytes For CPU and HF head module
n x 30 mm	1800 bytes + n x 88 bytes For basic and standard head

Table 4-1 Requirements for n SIWAREX CS modules

Each SIWAREX CS requires 8 bytes from the peripheral range of the head module. This information and the manual for the ET 200S decentralized peripheral system can be used to determine the maximum expansion. Depending on the head station, the maximum expansion for SIWAREX CS can be between 11 and 30 SIWAREX CS modules per head station.

Selecting the appropriate ET 200S head station, the SIMATIC CPU and the SIMATIC HMI (Human Machine Interface) is not based exclusively on the SIWAREX CS requirements but also on the overall task that the automation system has to perform.

4.2 Structure to EMC Guidelines

SIWAREX CS is a high precision measuring instrument, which must be able to reliably measure tiny signals (approx. 1 μ V). For this reason, proper assembly and wiring are absolutely essential for fault-free operation.

4.2.1 Definition: EMC

EMC (Electromagnetic Compatibility) describes the ability of an electrical device to function without faults in a defined electromagnetic environment without being influenced by its surroundings and without negatively influencing the surroundings.

4.2.2 Introduction

Although SIWAREX CS was developed for use in industrial environments and meets high EMC specifications, you should carry out EMC planning before

3BHardware Configuration and Assembly

installing your controller to determine and take into account any possible interference sources.

4.2.3 Possible Effects of Interference

Electromagnetic interference can influence the automation system and the SIWAREX CS in various ways:

- Electromagnetic fields that have a direct influence on the system
- Interference that infiltrates the environment through bus signals (PROFIBUS DP etc.)
- Interference through process cabling (e.g. measurement lines)
- Interference infiltrating the system through the power supply and/or protective ground

Interference can impair the fault-free functioning of the SIWAREX CS.

4.2.4 Coupling Mechanisms

Depending on the means of distribution (conductive or non-conductive bound) and the distance between the interference source and the device, interference can be introduced into the automation system through four different coupling mechanisms.

Galvanic coupling

Capacitive coupling

Inductive coupling

Radiation coupling

4.2.5 Five Basic Rules for Guaranteeing EMC

If you follow these five basic rules, EMC can reach the demands in most cases!

Rule 1: Large surface area grounding connection

Ensure that while installing the automation devices, a well-made large surface area ground connection is made between the inactive metal components (see following sections).

Connect all inactive metal components and low-impedance components with ground (broad cross-section).

Use screwed connections on painted or anodized metal surfaces either with special contact washers or remove the insulated protective surface at the contact points.

Do not use aluminum components for ground connections if at all possible. Aluminum oxidizes easily and is therefore less suitable for grounding connections.

Find a central location for connections between the grounding point and the ground wiring system.

Rule 2: Proper wiring

Separate the cabling into groups (high-voltage lines, power supply lines, signal lines, ground wiring, data lines etc.).

Run the high-voltage lines and ground wiring or data cables in separate channels or bundles.

Run measurement lines as close to grounding surfaces as possible (e.g. support beams, metal rails, cabinet panels).

Rule 3: Fixed cable shielding

Ensure that the cable shielding is connected properly.

Use shielded data lines only. The shielding must be connected to ground using a large surface area at both ends of the data lines.

The shielding of measurement lines must also be connected to ground at both ends.

The shielding should continue right up to the terminal connection. Unshielded cable ends should be kept as short as possible. Run cable shielding directly under the SIWAREX CS in the shielding channeling. The connection between the shielding rail and the cabinet/housing must be low impedance.

Use metallic or metal-plated connector housings for the shielded data lines.

Rule 4: Special EMC measures

All inductivity that is to be controlled should be connected with suppressors.

Use interference suppressed fluorescent lighting or incandescent lamps for illuminating cabinets or housings in the immediate vicinity of your controller.

Rule 5: Uniform reference potential

Create a uniform reference potential and ground all electrical operational elements.

If potential differences arise or can be expected between components of your system, install adequately dimensioned potential equalizing lines. For applications in areas with a risk of explosion, potential equalization is mandatory.

3BHardware Configuration and Assembly

4.3 Assembly

When assembling the SIMATIC components and the SIWAREX CS, the installation, assembly and wiring guidelines for the SIMATIC ET 200S must be followed (see manual for ET 200S decentralized peripheral system).

This manual describes supplementary aspects of assembly and wiring that are specific to the SIWAREX CS.

4.4 Connection and Wiring

4.4.1 Connection Areas for SIWAREX CS

All external connections run via the terminal block.

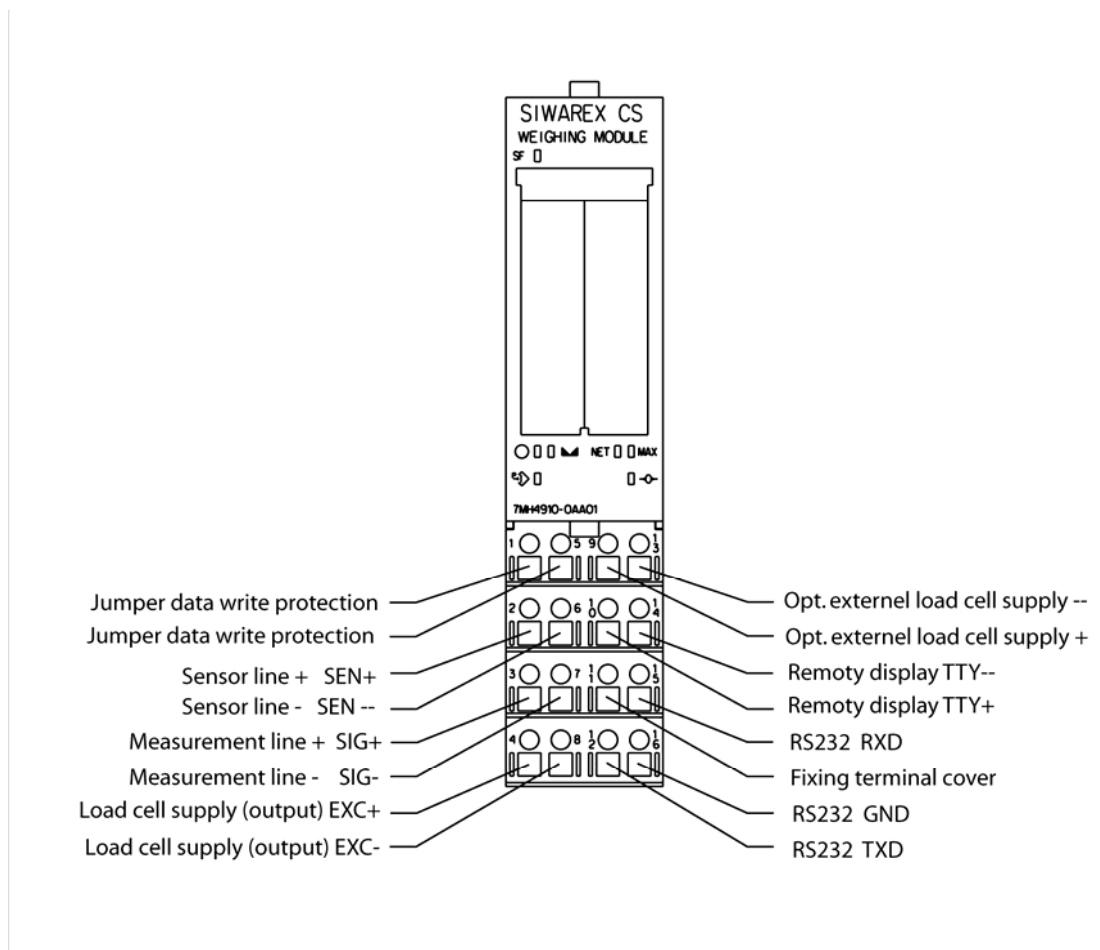

Figure 4-1 SIWAREX CS Connection Areas

4.4.2 Shielding connection

Special attention must be given to the shield strip for the shielded lines. Only correct installation guarantees that the system will be immune to interference. A wire is shielded to lessen the effect of magnetic, electrical and electromagnetic interference on it. Interference on cable shielding is routed to ground through shielding rails that are conductively connected with the housing. To ensure that this interference does not become a source of interference, a low impedance connection to ground is especially important.

Use only wires with braided shielding (see recommended cable types in chapter [11 Accessories](#)). Shielding should provide at least 80% coverage.

To fasten the braided shielding, use only the proper metal cable clamps. The clamps must cover as much shielding as possible and ensure a good contact. Shield clamps must be ordered separately from the grounding elements. Approximately 1.5 cm of the cable insulation must be exposed in the area of the cable to be fastened to the shielding clamp. The exposed shielding is then pressed firmly against the grounding element with the shielding clamp. The insulated cable shielding can then continue up to the terminal connection.

The following figure shows the assembly of the shield clamps.

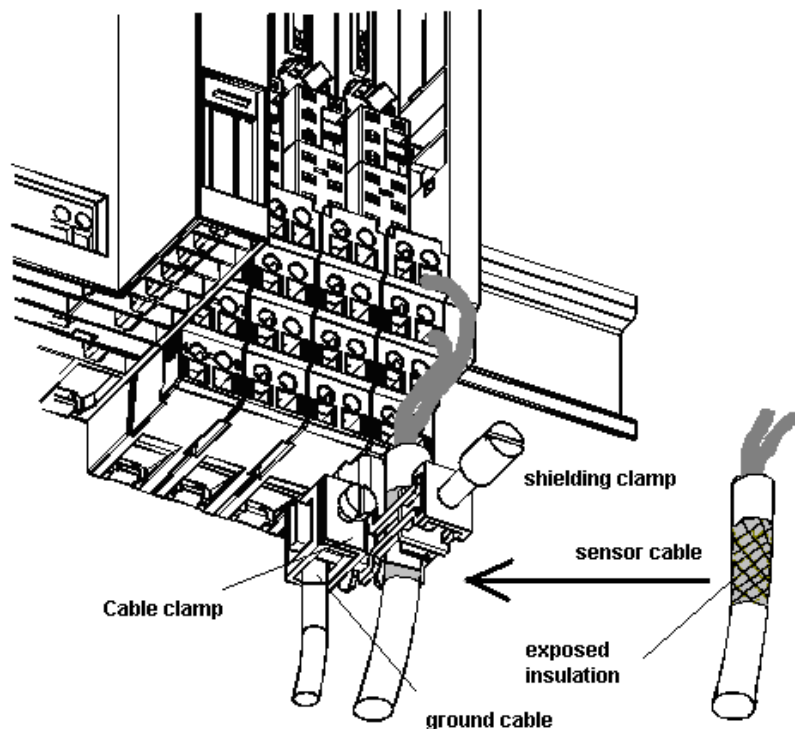

Figure 4-2 Assembly of Shield Clamps

The shielding should be pressed against the shielding rail by the screw in the shielding clamp.

3B Hardware Configuration and Assembly

4.4.3 Connection of 24 V Power Supply

The 24 V power supply is not connected directly to the terminal module for the SIWAREX CS module. The 24 V connection runs to the power module. The power module supplies the SIWAREX CS via the power supply rail.

4.4.4 Connections to Terminal Module

The load cells, the TTY and RS232 serial interfaces and the jumpers for protection of calibration data are connected to the terminal module.

4.4.5 Load Cell Connection

Measuring sensors can be connected to the SIWAREX CS if they are fitted with strain gauges and meet the following conditions (see also Technical Data – chapter [12.3](#)):

- Characteristic value 1.... 4 mV/V
- Supply voltage of 6 V is permissible

The following rules are to be followed when connecting load cells (LC).

1. Use of a junction box (SIWAREX JB) is necessary if more than one load cell is connected (the load cells must be connected in parallel). If the distance from a load cell to SIWAREX CS or to the junction box is greater than the available length of the load cell connecting cable, the SIWAREX EB (extension box) should be used.

2. The cable shielding is always run to the cable gland on the junction box (SIWAREX JB) or the extension box.

If there is a risk of potential equalization currents on the cable shielding, a potential equalization conductor should be run in parallel to the load cell cable.

3. Twisted pair cables should be used for the specified lines and should also be shielded:

- Sensor lines (+) and (-)
- Measuring voltage lines (+) and (-)
- Supply voltage lines (+) and (-)

We recommend that the cables specified in chapter [11 Accessories](#) are used.

4. The shielding must be attached to the shielding strip on the SIWAREX CS.

The maximum distance between the SIWAREX CS and the load cell is applicable when using the recommended cables.

The power supply (6V) for the load cells comes from the SIWAREX CS (terminal 4 and 8).

The connection should be made using the cable described in chapter [11 Accessories](#).

Connection in terminal block	Signal	Comment
2	SEN+	Sensor line +
6	SEN-	Sensor line -
3	SIG+	Measurement line (input) +
7	SIG-	Measurement line (input) -
4	EXC+	Load cell supply (output) +
8	EXC-	Load cell supply (output) -
9	EXTE+	Input +24V (electrically isolated) Only where necessary! Remote supply for load cells if the impedance is below 87Ω. The minimum permissible impedance is then 40Ω.
13	EXTE-	Ground input 24V Only where necessary! Remote supply for load cells if the impedance is below 87Ω. The minimum permissible impedance is then 40Ω.

Table 4-2 Load Cell Connection

For remote supply the 24V is applied at terminals 9/13.

The connections at terminals 6, 3, 7, 4, 8 are identical for both remote and internal supply.

The two figures below show the load cell connection using 4-wire and 6-wire systems.

3B Hardware Configuration and Assembly

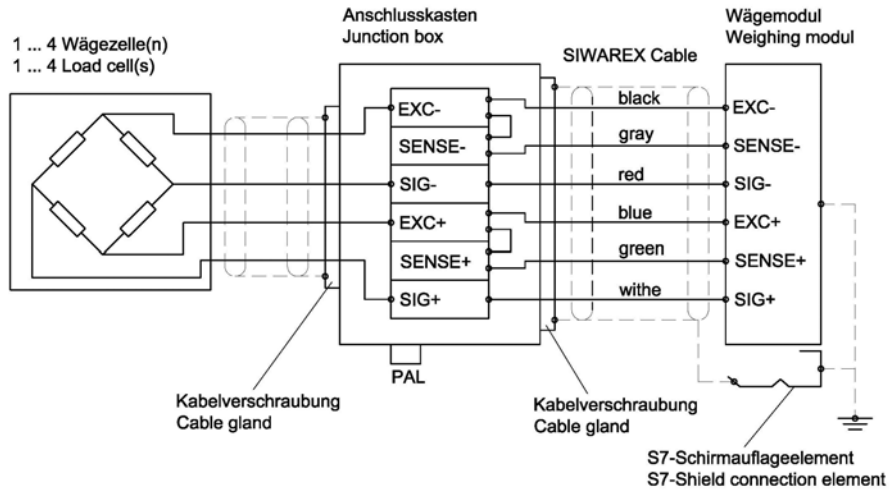

Figure 4-3 Load Cell Connection with 4-Wire System

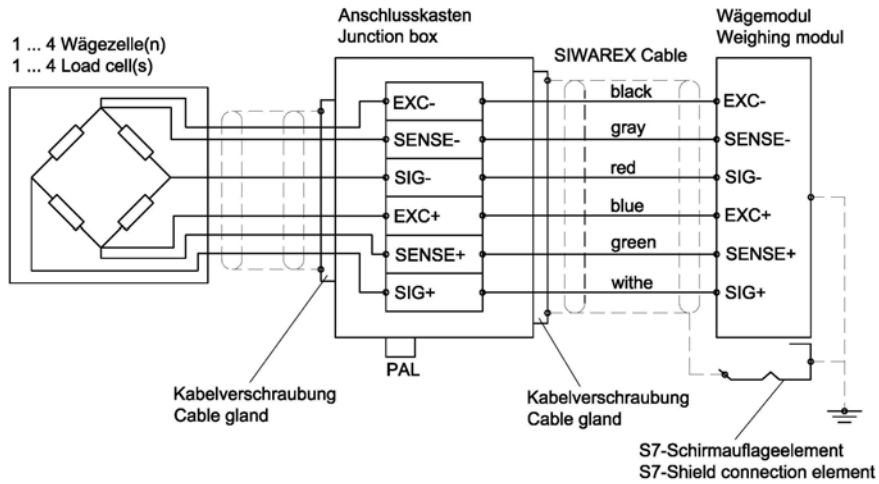

Figure 4-4 Load Cell Connection with 6-Wire System

The maximum distance of 1000 m applies to use of the cables specified in chapter [11 Accessories](#).

4.4.6 Connecting the Siebert Remote Display

The type S102 display made by Siebert can be connected to the TTY interface.

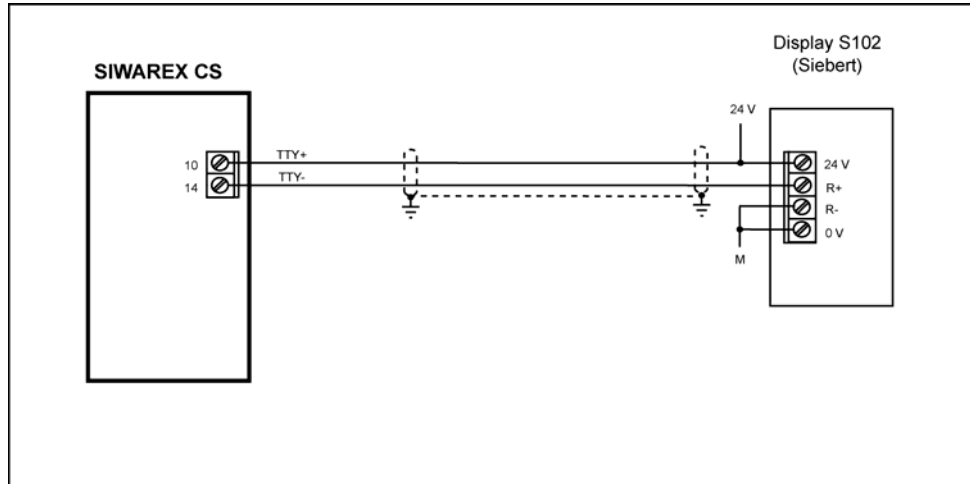

Figure 4-5 Connecting the S102 Display

4.4.7 Connecting the PC for SIWATOOL CS

Connection in terminal block	Signal	Comment
12	TXD	When using 7MH4 607-8CA connecting lead: Cable identifier "TxD"
15	RXD	When using 7MH4 607-8CA connecting lead: Cable identifier "RxD"
16	GND	When using 7MH4 607-8CA connecting lead: Cable identifier "GND"

Table 4-3 Connecting the PC

Ready made cables are available for connecting the PC (see [Accessories](#)).

3BHardware Configuration and Assembly

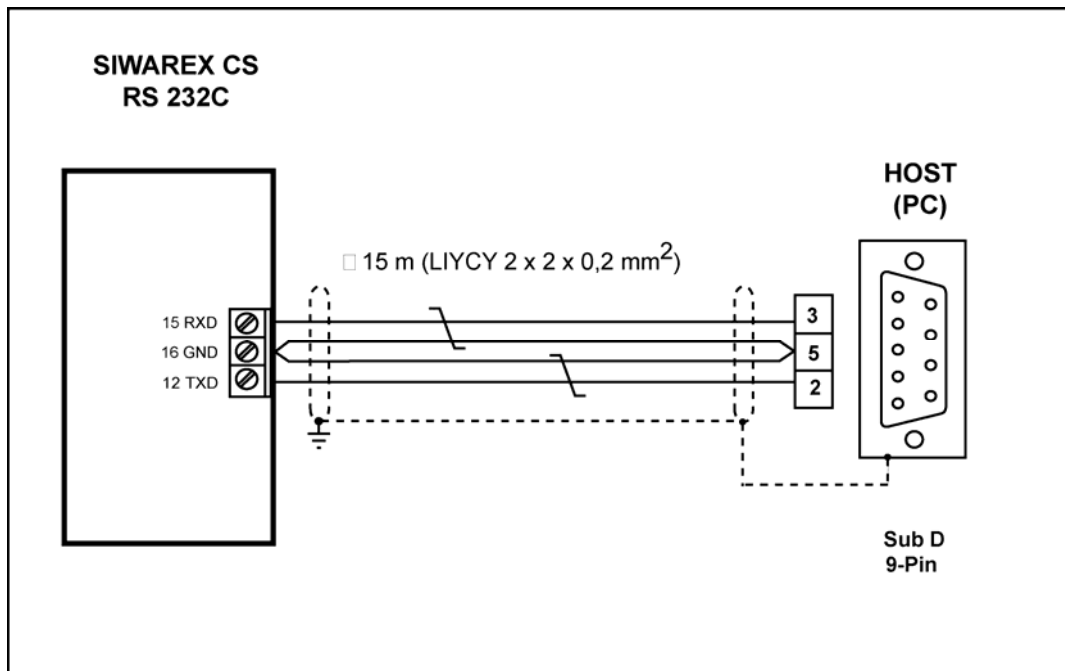

Figure 4-6 Connecting the PC

4.4.8 LED Display Elements



Label	LED color	LED	Description
SF	Red	LED 1	System Fault Hardware fault
	Green	LED 2	RUN
	Green	LED 3	Standstill
NET	Green	LED 4	Net
MAX	Red	LED 5	Max. exceeded
	Orange	LED 6	Write protection activated
→0←	Green	LED 7	¼ d zero

Table 4-4 Display Elements (LED)

For further information about the LEDs, see chapter [7.9](#).

4.5 Preparing for Operation

Introduction

At this point in the commissioning procedure, after assembling the module and making all connections, you should perform a partial functionality test for the SIWAREX CS and all connected components. The individual steps for partial testing are to be performed in the following sequence:

Visual check

Check all previously performed steps for proper execution:

- Does the SIWAREX CS have any external damage?
- Is the SIWAREX CS in the correct mounting slot?
- Are all connecting cables properly connected and fastened tightly?
- Is all shielding in place?
- Is the ground busbar connected to the ground bus?
- Is the U mounting channel connected to the ground bus?
- Have all tools, materials or components that do not belong to the S7 or SIWAREX CS been removed from the modules?

Turn on 24 V

Turn on power supply.

LED check on SIWAREX CS

After applying the 24V supply voltage and a short initialization phase (internal tests, indicated by LED running sequence), the SIWAREX CS goes into operating status. The following LEDs must have the status that is indicated below if the unit is running correctly:

LED (System Fault)	-->	Status OFF
LED (RUN)	-->	Status ON

For further information about the LEDs, see chapter [7.9](#).

4.6 Use for potentially explosive area



Danger

DANGER EXPLOSION

Exists when the installation and setup regulations are not adhered to.



For using the SIWAREX CS in areas with a risk of explosion, the important information in the „SIMATIC Automation Systems - Basics of Explosion protection (Doc.No. A5E00206200)“ must be observed!

Below you will find important information on the installation of the SIWAREX CS in a hazardous area.

SIWAREX CS may only be used under the conditions, which are specified in the appropriate certificates.

The SIWAREX CS can be used in Ex zone 2 (acc. to IEC/CENELEC, directive 94/9/EG).

In the following you find some details about the certificates ATEX (Europe) and UL (USA, Canada).

Certificate: ATEX:

Type Examination Certificate Number: ATEX Nr. KEMA 08ATEX0002 X



Please always observe the relevant safety instructions. These can be accessed on the Internet at

<http://support.automation.siemens.com/WW/view/en/29443327>

Certificate: c-UL-us haz. loc.

UL file number. USA: NRAG.E239877

UL file number Canada: NRAG7.E239877

Note to c-UL-us haz.loc:

Warning – Explosion Hazard – Do not disconnect while circuit is live unless area is known to be non-hazardous.

Warning – Explosion Hazard – Substitution of components may impair suitability for Class I, Division 2.

This equipment is suitable for use in Class I, Division 2, Groups A, B, C, D or non-hazardous locations only.

Connection from load cells to SIWAREX CS:

The SIWAREX CS can be connected with load cells in zone 1 or zone 2.

For a connection of load cells in zone 2 it is sufficient, that the load cells also have an approval for zone 2 and all associated directives as well as the installation instructions are respected.

For a connection of load cells in zone 1 load cells with the adequate approvals are needed and appropriate provisions according to the guidelines must ensure explosion protected operation. For example SIWAREX R load cells can be connected intrinsically safe via the Ex-Interface SIWAREX IS. The instructions for the Ex-Interface, the load cells and the ATEX as well as the c-UL-CSA directives have to be respected.

Installation and Maintenance:

Required connection and installation work must be performed by qualified personnel.

Repairs can only be carried out at the production location.

5 Weighing Functions

5.1 General

The SIWAREX CS can be used as a non-automatic weighing instrument or as measuring electronics for force measurement.

As supplied, all parameters are set to default values. The "Load factory setting" command can be used to restore the factory default parameters.

The default parameters are set so that the scale is immediately ready for operation. It is not necessary to re-enter all parameters. The advantage of this solution is that you can define how many of the default values should be retained and how much the behavior of the scale has to be adapted the specific application.

All parameters are divided into data records. The data records are organized by process steps (tasks) that have to be performed during commissioning or in the process itself.

In the following parameter description, you will find a description of the weighing functions that are influenced by that parameter.

First of all, the parameters in a data record are shown in a table. This is followed by a detailed description of the parameters in that data record.

After receiving new parameters, the SIWAREX CS performs a plausibility check. If there is a parameterization error, the SIWAREX CS does not accept (does not save) the data record and a "synchronous" message is output (see chapter [7 Messages and Diagnosis](#)).

5.2 DS3 Adjustment Parameter

The adjustment parameter must be tested for every scale and changed if necessary.

The scale is basically defined using the adjustment parameter and by performing the adjustment. In calibrating operation, the DS3 data can no longer be changed after acceptance of the calibration (jumper on terminals 1-5).

Procedure:

- Check all parameters and change if necessary.
- Send DS3 to the scale
- Perform scale adjustment
- Receive DS3 from the scale

Name	Type	Length	Default	Range of Values / Explanation
Adjustment digits for zero point	WORD	2	0	Scale zero point (JD0) [0 bis: 2 ¹⁶] Other definitions not permitted. For description see chapter 5.2.1
Adjustment digits for adjustment weight 1	WORD	2	60000	Adjustment digits for adjustment weight 1 (JD1) [0 bis: 2 ¹⁶] Other definitions not permitted. For description see chapter 5.2.1
Adjustment digits for adjustment weight 2	WORD	2	0	Adjustment digits for adjustment weight 2 (JD2) [0 bis: 2 ¹⁶] Other definitions not permitted. For description see chapter 5.2.1
Adjustment weight 1	INT	2	2000	Adjustment weight 1 (JG1) For description see chapter 5.2.1
Adjustment weight 2	INT	2	0	Adjustment weight 2 (JG2) For description see chapter 5.2.1
Characteristic value range	BYTE	1	2	1: Characteristic value range 1mV/V 2: Characteristic value range 2mV/V 4: Characteristic value range 4mV/V Other definitions not permitted. For description see chapter 5.2.2
Reserve	BYTE	1	0	0: Reserve, allways 0
Limit frequency for low pass filter fg	BYTE	1	4	3: fg = 5Hz 4: fg = 2Hz 5: fg = 1Hz 6: fg = 0.5Hz 7: fg = 0.2Hz 8: fg = 0.1Hz 9: fg = 0.05Hz Other definitions not permitted. For description see chapter 5.2.3
Filter depth – Average value filter	BYTE	1	15	Filter depth of average value filter [0 .. 255] 0 and 1: Average value filter deactivated >1: Filter depth For description see chapter 5.2.5
Scale name	STRING[10]	12	"SIWARE X CS"	Customer-specific description For description see chapter 5.2.6
Min. weighing range	INT	2	20	Minimum weight for weighing range For description see chapter 5.2.7
Weighing range	INT	2	2000	Maximum weight for weighing range For description see chapter 5.2.8
Numeral step	INT	2	1	Numeral step (1, 2, 5, 10) For description see chapter 5.2.9
Standstill range	INT	2	10	Standstill range in weight unit For description see chapter 5.2.11
Standstill time	TIME	4	1000	Standstill time in ms For description see chapter 5.2.10
Decimal place for remote display and ASCII weight output	BYTE	1	2	0..5 For description see chapter 5.2.12
Maximum negative weight for zero setting	BYTE	1	1	Neg. range of zero setting device [in % of WB _{max}] (Entry from Pos- + Neg. zero set value may not exceed 4% for "OIML" regulation code. For regulation code "----", the value may be a max. of 10%) For description see chapter 5.2.13
Maximum positive weight for zero setting	BYTE	1	3	Neg. range of zero setting device [in % of WB _{max}] (Entry from Pos- + Neg. zero set value may not exceed 4% for "OIML" regulation code. For regulation code "----", the value may be a max. of 100%) For description see chapter 5.2.14
Tare max. weight T-	BYTE	1	100	Subtractive tare device range [in % of weighing range (Entry may not exceed 100% with country code "OIML") For description see chapter 5.2.15
Reserve 1	WORD	2	0	Reserve 1
Regulations	STRING[4]	6	"----"	"OIML" : = Regulation code OIML "----": = No regulation code

4BWeighing Functions

Name	Type	Length	Default	Range of Values / Explanation
				For description see chapter 5.2.16
Unit	STRING[4]	6	"kg"	Weight unit for weight display For description see chapter 5.2.17
		56		

Table 5-1 DS3 Allocation

5.2.1 DS3 – Adjustment digits 0, 1, 2, for zero point and adjustment weights 1, 2

The analog measured value arriving from the load cells is converted into a digital value in an analog-digital converter. This digital value is then used to calculate a weight value. All functions of the SIWAREX CS then use this weight value to determine the status and for messages.

To calculate the weight value from the digital value, the characteristic curve of the measurement system must be determined. In the simplest case, the characteristic curve is defined by points 0 and 1. The first operating point (point 0) is always determined by the empty scale with its own construction weight. The weight of the scale's own construction causes the load cell to supply a measurement voltage to SIWAREX CS. After analog-digital conversion of the measurement voltage, the digital value (adjustment digits for zero point) is assigned the zero point.

If the scale is loaded with a known calibration weight (e.g. 100 % of the measurement range), then the second operating point can be determined. The new digital value from the analog-digital converter is now assigned the calibration weight.

In addition, the characteristic curve can be linearized using a further point lying above point 1.

Ensure that the difference between two adjustment weights is at least 5% of the measurement range.

The adjustment consists of the following steps:

Define adjustment weights and other parameters of the DS 3 data record.

Send DS 3 to the scale

With an empty scale, give the command "Valid adjustment weight = 0"

Load the scale with the defined calibration weight

Give the command "Valid adjustment weight = 1"

Receive DS 3 from the scale to pc

Save the data to a data carrier

The adjustment sequence for the increasing adjustment weights must be retained.

Example:

Zero point = 0.0 kg (always) gives 7800 digits

Adjustment weight 1 = 100 kg gives 60074 digits

This defines the characteristic curve (0 is entered as the weight value for further adjustment weights) and the scale can now perform the calculations for the weight values over the entire measurement range.

Note:

Since the theoretical maximum value for adjustment digits is 60074 and the value for completely empty load cells (without the weight of the construction itself) is 5461, the plausibility of the characteristic curve can be roughly estimated, to determine load deviations for example.

The illustration shows the relationship between the adjustment digits and the adjustment weight.

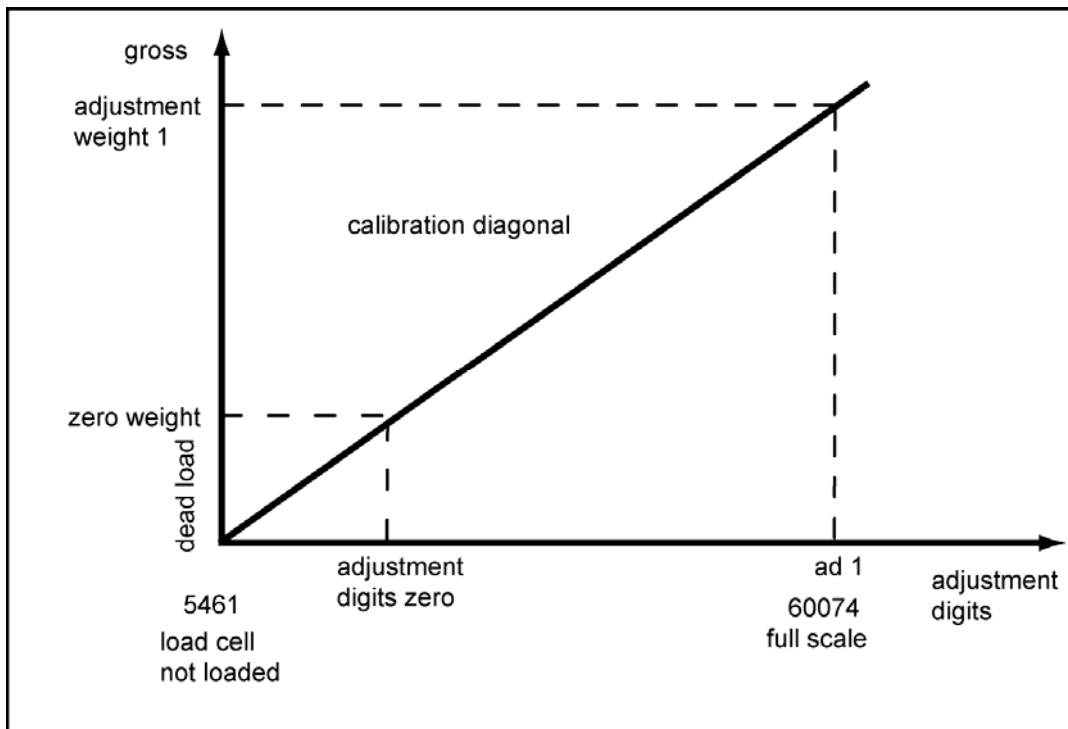

Figure 5-1 Adjustment Digits and Weight Value

If the adjustment weights and adjustment digits of a SIWAREX CS are known then the adjustment procedure does not need to be performed. They are simply sent to the SIWAREX CS in the DS3 data record and the scale is immediately operational (after official calibration of the scale, it is no longer possible to send DS3).

The SIWATOOL FTA program supports you in quickly performing an adjustment.

4BWeighing Functions

Option 1:

After commissioning and after adjustment, all data records for the scale are read from SIWAREX CS and are stored as a scale file ScaleX.SCS.

Identical scales can now be put into operation immediately. Connect the PC to the new scale and activate the "Send all data records" function. This also transfers the adjustment weights and the adjustment digits – the characteristic curve is defined immediately. Of course, the same applies for exchanging a SIWAREX CS.

Option 2:

Use the SIWAREX CS "Theoretical Adjustment" function and determine the characteristic curve for the scale from the technical data of the load cells alone. This case assumes proper construction of the scale.

Note:

Normally, defining two operating points is sufficient to determine the characteristic curve for the scale. A further operating point only has to be defined for non-linear systems – an additional calibration weight (e.g. 80% of the measuring range) is assigned a new digital value (adjustment digits 2).

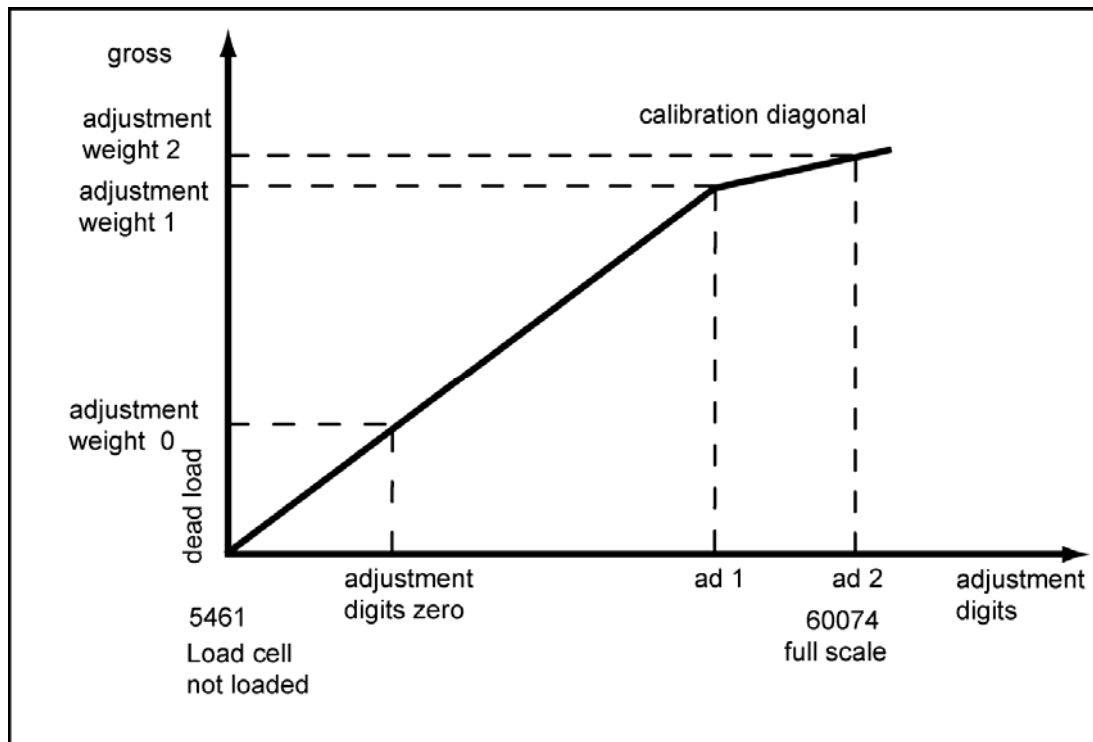

Figure 5-2 Linearization of Scale Characteristic Curve

5.2.2 DS3 – Characteristic Value Range

Depending on the characteristic value of the connected load cells, the value 1 mV/V, 2 mV/V or 4 mV/V must be selected. Since the SIWAREX CS supplies the load cells with approximately 6 V, the measuring input is modified according to the expected measurement voltage (max. 6 mV, max. 12 mV or max. 24 mV).

For example, if the characteristic value of the connected load cells is 2.85 mV/V then the next higher characteristic value must normally be set, i.e. 4 mV/V.

5.2.3 DS3 – Low Pass Filter

A critically energized low pass filter is provided for suppression of interference. The figure below shows the step response of the filter (fg = 2 Hz).

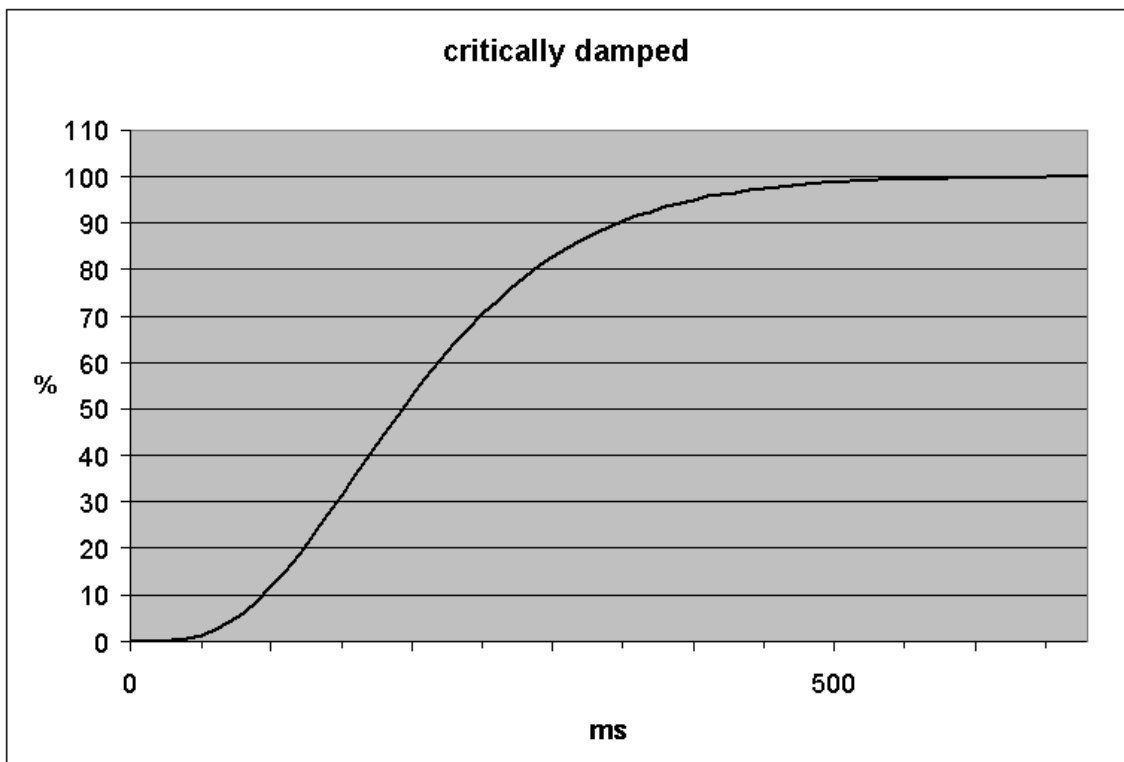

Figure 5-3 Step Response of Digital Low Pass Filter at fg = 2 Hz

4B Weighing Functions

5.2.4 DS3 – Limit Frequency

Defining the limit frequency is critically important for suppressing interference. The "speed" of the scale's reaction to the change in the measured value is determined by specifying the limit frequency.

For example, a value of 5 Hz results in a relatively fast scale reaction to a weight change, while a value of 0.5 Hz makes the scale "sluggish".

5.2.5 DS3 – Depth of Average Value Filter

The average value filter is used to settle the weight value against interference. The weight value is based on the average of the n weight values that the SIWAREX CS calculates every 20 ms, e.g. if $n=10$, 10 values are used to calculate the average value. Every 20 ms, the oldest value is dropped and the newest is included in the calculation.

The average value filter also achieves very good attenuation of periodic interference, if the interference frequency corresponds to an integral multiple of the relationship $1/(\text{filter depth} * 20\text{ms})$.

5.2.6 DS3 – Scale Name

The name consists of a maximum of 10 characters and can be freely selected.

Note:

The scale name can no longer be changed after official calibration.

5.2.7 DS3 – Minimum Weight for Weighing Range

The weight value can only be used for calibrating recording with the specified numeral step above the minimum weight. The minimum weight is defined by an adjustment or a calibration. The minimum weight depends on the number and type of load cells used.

The value can be set to 0 on non-calibrating scales.

5.2.8 DS3 – Weighing Range

The weight can only be used for calibration purposes with the specified numeral step below the maximum weight. The maximum weight is defined during adjustment. The "integer" number format limits the entry to a maximum of 32767.

The maximum weight depends on the number and type of the load cells used and may not exceed $2000 \times$ numeral step in calibrating applications.

5.2.9 DS3 – Numeral Step for Weighing Range

In accordance with the EN 45501 standard, the numeral step for the weighing range can be specified in steps of 1, 2, 5 or 10.

5.2.10 DS3 – Standstill time

Standstill monitoring is used to identify when the scale is at a stable equilibrium. Scale standstill is determined if the weight value changes by less than a defined

deviation range (standstill value) within a defined time (standstill time). Standstill monitoring is used in static operation of the scale (for commands: Zero, Tare).

5.2.11 DS3 – Standstill Range

Standstill monitoring is used to identify when the scale is at a stable equilibrium. Scale standstill is determined if the weight value changes by less than a defined deviation range (standstill value) within a defined time (standstill time). Standstill monitoring is used in static operation of the scale (commands: Zero, Tare). The figure below illustrates the functioning of the standstill monitoring feature.

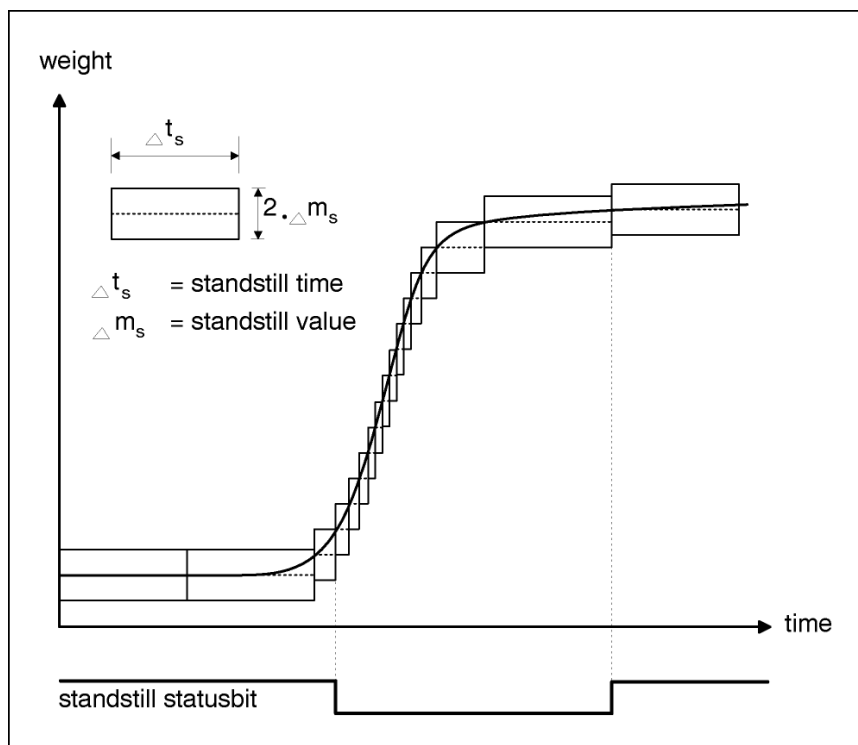

Figure 5-4 Standstill Monitoring

5.2.12 DS3 – Decimal Place for Remote Display and ASCII Weight Output

A decimal place can be specified for the Siebert remote display connected and for ASCII weight output in DS30. As the decimal place cannot be shown in the 16 bit numerical representation, all weight entries are assumed to have this decimal place.

For example, if the decimal place is set to 2, the measuring range of 20 kg should be specified as 2000. In ASCII weight output in DS30, at nominal load the value of 20.00 kg is output. At the same time, the weight value is output to the SIMATIC interface as a process value of 2000.

4B Weighing Functions

5.2.13 DS3 – Maximum Negative Weight for Zero Setting

For zero setting, the current weighing signal from the scale is defined as the zero weight.

For zero setting, the specification can be used to limit the effect of the function. The reference point for the effect of the limitation is not the current gross weight but the weight that the scale would display without the preceding zero settings (from time of scale adjustment).

For scales in calibrating operation, the limit between the negative and positive weight for zero setting is 4% of the weighing range.

5.2.14 DS3 – Maximum Positive Weight for Zero Setting

For zero setting, the specification can be used to limit the effect of the function. The reference point for the effect of the limitation is not the current weight but the weight that the scale would display without the preceding zero settings (from time of scale adjustment).

For scales in calibrating operation, the limit between the negative and positive weight for zero setting is 4% of the maximum weighing range.

5.2.15 DS3 – Tare Max. Weight T-

The SIWAREX CS will accept any external tare specification, which is smaller than the max. tare weight (percentage of weighing range). The tare commands are also accepted as long as the current gross weight is still below the tare max. weight that can be parameterized.

The value is limited to 100% of the maximum weighing range.

5.2.16 DS3 – Regulations

Scales in calibrating operation are subject to certain restrictions. The "OIML" entry activates these restrictions. To deactivate them, it is necessary to enter "----".

5.2.17 DS3 – Unit of Measurement

A 4-digit character string can be specified as the unit of measurement, e.g. t, kg, lbs. The specified unit of measurement applies to all weight data. When the unit of measurement is changed, no conversion is performed.

5.3 DS 4 Limit Value Parameters

In DS4, the switch on and switch off values for the limit values are parameterized.

DS4 is not subject to write protection in calibrating operation.

Procedure:

- Check all parameters and change if necessary.
- Send DS 4 to the scale

Name	Type	Length	Default	Range of Values / Explanation
Switch on value Limit value 1	SHORT	2	400	Switch on point, limit value 1
Switch off value Limit value 1	SHORT	2	220	Switch off point, limit value 1
Switch on value Limit value 2	SHORT	2	1000	Switch on point, limit value 2
Switch off value Limit value 2	SHORT	2	980	Switch off point, limit value 2
Limit value parameter flag	UBYTE	1	0	<i>Bit 0 GW1 gross/net reference for GW1</i> 0 = Limit value 1 works on gross weight 1 = Limit value 1 works on net weight <i>Bit 1 GW2 gross/net reference for GW2:</i> 0 = Limit value 2 works on gross weight 1 = Limit value 2 works on net weight <i>Bit 2 to 7 not used</i>
Reserve 1	UBYTE	1	0	Reserve 1
		10		

Table 5-2 DS 4 Allocation

5.3.1 DS 4 – Switch On Weight, Limit Value 1

Switch on and switch off weights can be defined separately for each limit value. In this way, a minimum value monitor and a maximum value monitor can be realized by hysteresis.

A maximum value monitor is realized with the following specification:

Switch on value > Switch off value

A minimum value monitor is realized with the following specification:

Switch on value < Switch off value

The figure below illustrates the function of limit values 1 and 2.

4BWeighing Functions

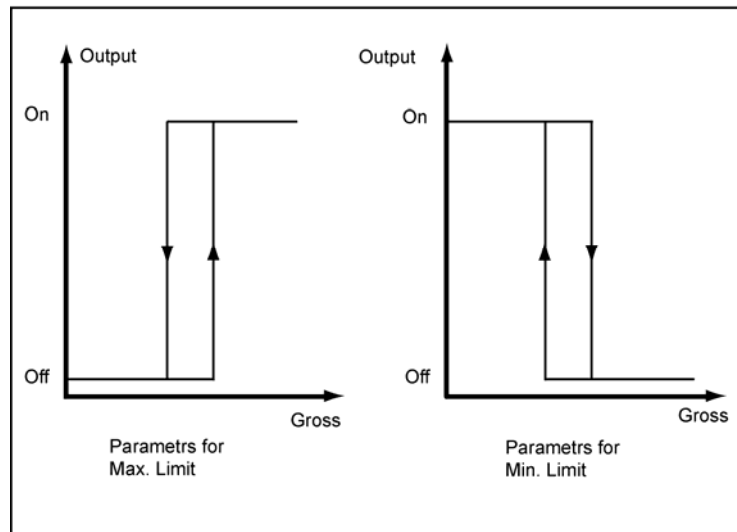

Figure 5-5 Parameterization of Limit Values

5.3.2 DS 4 – Switch Off Weight, Limit Value 1

See: Switch On Weight, Limit Value 1

5.3.3 DS 4 – Switch On Weight, Limit Value 2

See: Switch On Weight, Limit Value 1

5.3.4 DS 4 – Switch Off Weight, Limit Value 2

See: Switch On Weight, Limit Value 1

5.3.5 DS 4 – Basis Weight for Limit Values

The limit values can be defined in relation to the gross weight or the net weight of the scale.

5.4 DS 9 Info on Module

No entries can be made in DS9. The data record is used for information about the module's firmware version.

Name	Type	Length	Default	Range of Values / Meaning / Display
Module name	STRING[10]	12	SIWAREX CS	Name of weighing module
MLFB (20 characters)	STRING[20]	22	7MH4910- 0AA01	MLFB (20 characters) from DS162
Edition 1 HW	WORD	2	1	HW version (from DS162) hexadecimal
Firmware version	STRING[4]	6	V1.0	FW version (from code) e.g. V1.0

CRC checksum of package	WORD	2	----	Depending on code
		44		

Table 5-3 DS 9 Allocation

The purpose of the information in data record 9 is to identify the module, the hardware and the firmware.

5.5 DS 15 Tare Entry

DS 15 is used for external specification of the tare weight.

Procedure:

- Enter tare weight
- Send DS 15 to the scale
- Activate the command "Accept tare entry (24)"

Name	Type	Length	Default	Range of Values / Explanation
Tare input value	INT	2	0	Tare input value (preset Tare pT)
		2		

Table 5-4 DS 15 Allocation

5.5.1 DS 15 – Tare Entry

DS 15 is used for external specification of the tare weight. Once specified with DS 15, the tare value is not yet activated. It is then transferred to the SIWAREX CS tare memory using the command "Accept tare entry" (see command code 24). The specified tare value is rounded to the numeral step set in the parameters. The rounded tare value is output in DS 30.

5.6 DS 26 Internal Process Values

DS 26 is used to store the current internal process values. You can read these values, save them and back them up to the SIWAREX CS (not possible in calibrating operation). However, you may not change the values. Procedure:

- Read off values.
- Send values to SIWAREX CS if necessary (after replacement of module).

Name	Type	Length	Default	Range of Values / Explanation
Checksum	WORD	2	0	Checksum
	BYTE	1	0	Reserved
Preset tare	BYTE	1	0	1 = Tare memory contains ext. default value
Tare process value *100	DINT	4	0	Tare weight * 100
Zero set value *100	DINT	4	0	Zero set value * 100 (set during zero setting)
		12		

Table 5-5 DS 26 Allocation

4BWeighing Functions

5.7 DS 30 Process Values

The current states and data in the scale can be monitored using process values.

Name	Type	Length	Default	Range of Values / Explanation
Checksum	WORD	2	---	Checksum CRC16 from next byte
Scale status	WORD	2	---	Scale status For description see chapter 5.7.1
Operating error bits	BYTE	1	---	Operating error bits For description see chapter 5.7.2
Reserve	BYTE	1	0	Reserve 1
Gross process value	INT	2	---	Gross weight For description see chapter 5.7.3
Net process value	INT	2	---	Net weight For description see chapter 5.7.4
Tare process value	INT	2	---	Tare weight For description see chapter 5.7.5
G/N weight	INT	2	---	Calibration G/N weight value for display and logging purposes. For description see chapter 5.7.6
G/N weight *10	DINT	4	---	Calibration B/N weight value with 10x resolution (basis for ASCII weight value) For description see chapter 5.7.7
Tare weight	INT	2	---	Calibration tare weight value For description see chapter 5.7.8
Unfiltered raw value	WORD	2	---	Unfiltered digital value from ADU For description see chapter 5.7.9
Filtered raw value	WORD	2	---	Filtered digit value from filter level For description see chapter 5.7.10
Weight value ASCII	STRING[14]	16	---	Calibration ASCII weight value (temporarily at higher resolution after command) For description see chapter 5.7.11
Millisecond	INT	2	0	Runtime – Milliseconds (0...999) For description see chapter 5.7.12
Second	BYTE	1	0	Runtime – Seconds (0...59)
Minute	BYTE	1	0	Runtime – Minutes (0...59)
Hour	INT	2	0	Runtime – Hours (0...32000)

46

Table 5-6 DS 30 Allocation

5.7.1 DS 30 – Scale Status

The status information provides details of the current state of the scale.

Bit_No	Name	Range of Values / Explanation
0	Limit value 1	1 = Limit value 1 has responded
1	Limit value 2	1 = Limit value 2 has responded
2	Scale tared	1 = Tare memory occupied ($\neq 0$)
3	Preset tare	1 = Tare memory contains ext. default value
4	Max+9e	1 = Gross weighing range exceeded or undershot by more than 9 display steps
5	1/d zero	1 = Gross less than $\pm 0.25d$ (d corresponds to set numeral step)
6	Standstill	1 = Standstill exists

Bit_No	Name	Range of Values / Explanation
7	Module calibrated	1 = Module calibrated
8	Calibration parameter entry blocked	1 = Write protect switch active; (No calibration parameters or adjustment commands can be sent)
9	Min. weighing range undershot	1 = Min. weighing range undershot
10	--	--
11	--	--
12	--	--
13	--	--
14	--	--
15	Module fault	1 = Global module fault / operating error (SF)

Table 5-7 Status Information

5.7.2 DS 30 – Operating Errors

The byte displays the current operating errors.

Bit No.	Name	Comment
0	1= Reboot due to RAM error	See message list, chapter 7.8
1	1= Reboot due to watchdog error	See message list, chapter 7.8
2	1= Reboot due to program error	See message list, chapter 7.8
3	1= Number overflow in weight calculation	See message list, chapter 7.8
4	1= Parameter error	See message list, chapter 7.8
5	1= AD converter at limit of measuring range	See message list, chapter 7.8
6	1= Minimum voltage undershot on sensor line	See message list, chapter 7.8
7	1= AD converter fault	See message list, chapter 7.8

5.7.3 DS 30 – Gross Process Value

The current gross weight value.

5.7.4 DS 30 – Net Process Value

The current net weight value.

5.7.5 DS 30 – Tare Process Value

The current tare weight value.

4BWeighing Functions

5.7.6 DS 30 – G/N Weight

The current weight value, which is shown in the scale's main display (external remote display, type Siebert S102).

5.7.7 DS 30 – G/N Weight_x10

The current weight value with a higher resolution, which can be displayed temporarily in the main display (external remote display type Siebert S102) for a duration of 5 seconds.

5.7.8 DS 30 – Tare

The current tare weight, in the resolution specified by the numeral step (DS3).

5.7.9 DS 30 – Unfiltered Raw Digit Value from AD Converter

The current digit value from the AD converter without digital signal filtering.

5.7.10 DS 30 – Filtered Digit Value from AD Converter

The current digit value from the AD converter after digital signal filtering.

The filter parameters are specified in DS3.

5.7.11 DS 30 – ASCII Weight Value

The current weight value as sent to the main scale display (external remote display, type Siebert S102). This string can also be shown in a window in the SIMATIC HMI operator or touch panel.

5.7.12 DS 30 – Runtime Duration

When the SIWAREX CS module is switched on, a timer is started to ensure correct assignment of the messages in the message buffer. When the messages are entered in the message buffer, they are given the current time value from this timer.

6 Commands

6.1 Command Groups

The SIWAREX commands are divided into groups. The composition of the commands in a group is based on the functional context.

Every command has a unique number. A command can be sent via various interfaces (SIMATIC, SIWATOOL CS).

Each time a command is sent to SIWAREX CS a check must be made of whether the command has been correctly executed. The data and operating errors (synchronous errors, see chapter 7.7) generated provide information on why the command could not be executed.

The **service and adjustment commands group** is used during commissioning of the scale.

The **scale commands group** contains all commands relating to the handling of a static scale (e.g. zero setting, tare).

After receiving a command, SIWAREX CS checks whether the command can be executed. If the check results are negative, the user is informed of the cause by the output of a "synchronous" message (see chapter 7.7).

6.2 Command List

Code	Command explanation	Comment
	Service and adjustment commands	
1	Back up DS4 in Flash Back up limit value parameters in Flash (DS4)	
2	Back up DS26 in Flash Back up tare and zero setting value in Flash (DS26)	
3	Adjustment command zero point valid Zero point command valid (activates calibration mode)	Executable if no write protection (jumper 1-5)
4	Adjustment command Adjustment weight 1 valid The first adjustment point is determined by the	Executable if no write protection (jumper 1-5)

5BCommands

Code	Command explanation	Comment
	calibration weight.	
5	Adjustment command Adjustment weight 2 valid The second adjustment point is determined by the second calibration weight	Executable if no write protection (jumper 1-5)
8	Predefine all data records with default values All parameters are set to the status that was assigned originally by the manufacturer.	Executable if no write protection (jumper 1-5)
15	Characteristic curve shift The instruction shifts the entire characteristic curve (adjustment coordinates) so that the current filtered digital value from the ADC is made into a zero point. If an impermissible digital value results from the shift then the instruction is rejected.	Executable if no write protection (jumper 1-5)
	Scale commands	
21	Scale zero setting The current weight is set to zero. In calibrating operation ("OIML") only possible around zero point (e.g. -1%, +3%). The tare is simultaneously deleted.	
22	Tare The current weight is set to zero and the weight display is simultaneously designated as "Net".	
23	Delete tare The tare is deleted. The current weight is displayed and the designation is changed from "Net" to "Gross", the "Net" designation and, if necessary, the "Preset tare" status is reset.	
24	Accept tare entry from DS 15 The tare entry is accepted as the tare, the weight display is simultaneously designated as "Net" and the "Preset tare pT" is set.	
25	Switch on increased resolution Activate output / display of calibration weight value with increased resolution for 5 seconds.	
26	Transfer tare weight from S7 control range	

Code	Command explanation	Comment
	Tare specification from S7 control range valid. The weight display is simultaneously designated as "Net" and the status "Preset tare pT" is set.	

Table 6-1 SIWAREX CS Command List

More commands can be activated on the SIMATIC S7 interface of the FB SICS...

Command group	Description
1... 99	Commands are passed on to the module group without reading or writing from or to data records (scale, weighing, logging commands). The meanings of these commands correspond to the settings in Table 6-1 SIWAREX CS Command List . The numbers for existing commands are permissible.
203... 230	Reading a data record 3...30. The numbers for existing data records are permissible.
403... 426	Writing a data record 3...26. The numbers for existing data records are permissible.
605	Read all data records in SIWAREX CS (DS3, DS4, DS9, DS15, DS30)
610	Write the data records DS3, DS4, DS15 to the SIWAREX CS

Table 6-2 SIWAREX CSCommand Groups

More information on transferring commands from the control program using the SIMATIC interface can be found in chapter [8 Programming in SIMATIC STEP 7](#).

7 Messages and Diagnosis

7.1 Message Types

The SIWAREX CS messages are divided into several types.

The **asynchronous** messages (see chapter 7.8) can be generated spontaneously at any time due to an unforeseen event. These include internal and external hardware faults (operating messages) that can occur spontaneously during a weighing procedure.

The **synchronous** messages (see chapter 7.7) always occur in response to a command.

Data errors exist if a plausibility error is determined in a data package sent to the module and the module refuses to accept the data package. Operating errors exist if the module is unable to execute the given command in its current operating state.

By contrast, the status bits (see chapter 5.7.1) are not messages. The status displays describe the status of the scale in normal operation and can be monitored or evaluated at any time.

7.2 Message Paths

The SIWAREX CS messages are passed on to the operator by various paths. During configuration, it is important to choose the right path for routing and processing the messages.

Essentially, the messages are processed for two purposes:

- For display on an operating panel
- For connection to control software to control certain reactions in a process.

The following message paths are possible:

- Output message buffer to the SIWATOOL CS program
- Output via the SICS function block to its message outputs
- Diagnostic alarms in SIMATIC CPU with OB82 evaluation
- Process alarms (for limit value monitoring only) in the SIMATIC CPU with evaluation of the process alarm OBs

7.3 Detection of Messages Using SIWATOOL CS

A message buffer is integrated into the module and can hold up to 99 entries. If the number of messages in the message buffer reaches 99 then a new message will immediately delete the oldest message. The message buffer can be read at any time using SIWATOOL CS (menu option "Read all data records") and can be saved along with the scale parameters. This assists in detecting, analyzing and resolving problems in the system.

7.4 Detection of Messages Using FB SICS...

All of the messages in the SIWAREX module can be fully detected and processed in the controller using FB SICS.... Errors in the functioning of FB SICS... are also signaled via an output variable FB_ERR (see chapter [8 Programming in SIMATIC STEP 7](#).)

7.5 Detection of Messages Using the Diagnostic Alarms in the SIMATIC CPU

With certain head modules, operating messages (hardware faults) are detected in the SIMATIC CPU using diagnostic alarms. For more information, see chapter [8 Programming in SIMATIC STEP 7](#).

7.6 Detection of Messages Using Process Alarms

The process alarms allow a change of state of the limit values to be detected very quickly.

7.7 List of Data and Command Messages (synchronous messages)

Error No.	Data and operating messages - Meaning	Description
1	Unknown command code	The SIWAREX does not recognize the command code or the data record in the parameterized mode or is unable to process the command or data record in the current operating state.
2	Unknown data record	The specified data record does not exist.
4	Reserve	
5	Calibration parameter transfer, transfer of int. process values and adjustment commands not permissible with active write protection	The calibration parameters (DS3), the int. process values (DS26) and the adjustment commands may only be transferred if write protection is inactive (jumper inserted between connecting terminals 1-5). First deactivate the write protection.
7	Command can only be executed at standstill	The command can only be executed when the scale is at a standstill. Wait until it is at a standstill or change the standstill parameters in DS3.
8	Minimum time span between two commands not observed	There must be a waiting time of at least 5 seconds between two successive commands. This applies to the command codes 1, 2, 3, 4, 5, 8.
20	Command only permissible with adjusted scale	Scale commands can only be executed if the module has been calibrated. First calibrate the module.
21	Module failure	Command is not permissible due to a module failure.
77	Regulation code not permitted	Regulation code is incorrect. Enter the correct code. The permitted entries are ---- or OIML.
78	Zero setting range > 4%	The zero definition range or zero setting range is too large. This is the case if you have specified a zero definition range of > 4% of the weighing range in DS3 in calibrating operation (regulation code OIML in DS3). The sum of the negative and positive values apply in this instance. Reduce the zero definition range.
80	Incorrect standstill range	The specified standstill range is not plausible.
81	Incorrect decimal place	The specified decimal place for remote display is not plausible. Permitted values are 0...5.
82	Numeral step not plausible	At least one numeral step is incorrect in DS 3. The following values are possible as the numeral step: 10, 5, 2, 1. In calibrating operation (regulation code OIML in DS3), the numeral step may not be less than a 200th of the weighing range.
83	Filter parameter implausible	The filter parameter definition is not plausible in DS 3. Check the limit frequency (select 0..9).
84	Characteristic value not plausible	The specified characteristic value is incorrect in DS 3. Set the parameter to a valid value (1, 2 or 4).
85	Adjustment weight implausible	At least one weight setting for scale adjustment is not plausible.
86	Adjustment weight error	The specified adjustment weights are incorrect. The weight values must be ascending or 0 if they are not

Error No.	Data and operating messages - Meaning	Description
		used.
87	Defined percentage incorrect	A defined percentage is incorrect. The specification for the zero setting value or max. tare weight may not exceed 100%.
88	Negative value not permitted	A parameter contains a negative value that is not permitted.
94	Adjustment weight too low	The adjustment weight is too low in DS 3. Increase the adjustment weight interval. The measured values between successive adjustment weights must have an interval of at least 5% of the measuring range.
96	Tare T- invalid	The subtractive tare has been exceeded. This error is generated in the following cases: <ul style="list-style-type: none"> ▪ The gross value lies above the defined permitted tare range for the taring command. ▪ An externally specified tare value is negative.
100	Weight outside zero definition range	Zero definition cannot be executed since the current zero point lies outside the zero definition range defined in DS 3 or the current gross value lies above the highest defined weighing range value.
171	Checksum error	Checksum error in data record 26. The data was falsified or the DS versions do not match.
172	Error saving data record	An error occurred while saving the data record to the Flash memory.
173	Data record transfer error	An error occurred while transferring the data record. The data record was not transferred.

Table 7-1 List of Data and Operating Errors

7.8 Message List for Operating Messages (Asynchronous Errors)

If an error generates an operating message, the red SF LED on the front of the module is illuminated. The incoming and outgoing operating messages are signaled in the diagnostic buffer.

Error No.	Operating messages - Meaning	Description
1	Reboot due to error in RAM read-write testing	The error can mean that the module is defective.
2	Reboot due to watchdog error	The module had to be reset because of a critical error.
3	Reboot due to program error	The error can mean that the module is defective. Contact the SIWAREX Hotline.

6B Messages and Diagnosis

Error No.	Operating messages - Meaning	Description
4	Lost process alarm	Process alarm lost (on the S7 interface)
5	Parameter error	The parameters are not consistent (the checksum is incorrect). Re-transfer all data records.
7	Number overflow	A number overflow occurred in the weight calculation.
17	Limit for load cell signal exceeded or undershot	The measurement signal is too high. Measure the measurement voltage with a multimeter and check the load cells. Check the set characteristic value in DS3.
18	Wire break	The connection to the load cells has been broken. Check the load cell connection.
19	ADC error	The AD converter had to be restarted due to a fault.
20	Reboot after voltage recovery	Information about completed reboot only.
21	Reboot after firmware error	Information about completed reboot only.

Table 7-2 List of Operating Messages

The operating messages can be output to the SIMATIC interface as a byte. The meaning of individual bits is summarized in the table below.

Bit No.	Range of Values / Meaning
0	1= Reboot due to RAM error
1	1= Reboot due to watchdog error
2	1= Reboot due to program error
3	1= Number overflow in weight calculation
4	1= Parameter error
5	1= AD converter at limit of measuring range
6	1= Minimum voltage undershot on sensor line
7	1= AD converter fault

Table 7-3 Error Byte for Operating Messages

7.9 Messages via LEDs

The LEDs on the front of the SIWAREX CS are used to signal the following status and error messages.





Label	LED color	LED	Description	State display during operation
SF	Red	LED 1	Error display System Fault (hardware fault, operating error)	OFF: No operating error ON: Operating error
	Green	LED 2	Status and error display RUN	OFF: Fatal error / defect ON: Module in cycle Flashing: S7 bus error Flashes together with write protection LED  : weighing instrument not calibrated
	Green	LED 3	Status display Standstill	OFF: No standstill ON: Standstill
NET	Green	LED 4	Status display Net	OFF: Scale tared (net weight is output) ON: Scaled not tared (net weight is output)
MAX	Red	LED 5	Status display Max. exceeded	OFF: G/N weight within permissible weighing range ON: Weighing range exceeded by more than 9 calibration values Flashing: The measurement signal from the load cell is out of range
	Orange	LED 6	Status display Write protection	OFF: Write protection not activated ON: Write protection activated
→0←	Green	LED 7	Status display ¼ d zero	

Table 7-4 List of LED Messages

8 Programming in SIMATIC STEP 7

8.1 General

The SIWAREX CS was specifically developed for operation in the SIMATIC ET 200S.

The hardware setup is described in detail in chapter [4 Hardware Configuration](#).

You can find the SIWAREX CS module in SIMATIC HW catalog in PROFIBUS DP, ET 200S in the group of function modules.

If you can not find SIWAREX CS in the SIMATIC Manager the SIWAREX CS module must first be inserted in the HW catalog. Select the function "Install HW updates" from the „Tools“ menu. You can update the HW catalog via internet.

The example program – "Getting Started" is part of the configuration package. It contains the S7 blocks necessary for operation of the SIWAREX CS in SIMATIC. The example program also shows how application software can be created. We recommend using the example program and expanding it for different applications.

8.2 Performance Differences with Different Head Modules

Various head modules with a different range of functions can be used in the ET 200S system. The available scope of communication with SIWAREX CS and the diagnostic functions depend on the head module used.

If you are using head modules which do not allow data record communication (without DP V1), for example current basic modules, the scale is only adjusted and calibrated using the SIWATOOL CS PC program. In this case, only the weighing result and the status information is available in SIMATIC.

If you are using head modules which allow data record communication (with DP V1), for example current standard or high-feature modules, SIWAREX CS can be set either with SIWATOOL CS or via SIMATIC. In this case, the communication of data records means that all scale parameters can be accessed in SIMATIC.

8.2.1 Communication

Head modules which do not support the DP V1 protocol have no data record communication.

8.2.2 Alarm Functions

Head modules without data record communication

Group diagnostics – yes; hardware interrupt – no; (diagnostics information in HW Config under module information for the head module).

Head modules with data record communication

Group diagnostics – yes; hardware interrupt – yes; (diagnostics information in HW Config under module information for the head module).

8.3 SIWAREX CS in HW Config

Planning of the hardware configuration in SIMATIC Manager involves definition of the basic properties of the module:

- Peripheral address of the module
- Release of alarms

SIWAREX CS requires 8 bytes in the input and output areas.

8.4 SIWAREX CS in Cyclic STEP 7 Program

SIWAREX CS communicates with the SIMATIC CPU using the function block. Different function blocks are available for the different head modules:

8.4.1 SICS_BA for Basic Head

When programming the call, an instance data block is created for FB SICS_BA. As well as the instance data block, each SIWAREX CS scale requires a scale DB, in which certain parameters are stored. The UDT22 supplied can be used to create the scale DB22.

8.4.2 SICS_DR for the Standard Head, the High Feature Head and CPU Head

When programming the call, an instance data block is created for FB SICS_DR. As well as the instance data block, each SIWAREX CS scale requires a complete scale DB, in which the scale parameters are stored. The UDT21 supplied can be used to create the scale DB. In addition, the vector DB for FB SICS_DR must be loaded in the SIMATIC CPU. A vector DB can be used by several SIWAREX CS modules.

8.4.3 FB SICS... Call

The FB SICS... function block and data blocks are located on the SIWAREX CS configuration package for SIMATIC S7 CD in the directory Getting_Started_CS as a component of the "Getting started" example program. The project consists of several stations. To continue, select the appropriate station for your configuration. In the user program, the function block FB SICS... is called once for each scale cyclically in a program level (e.g. in OB1) and supplied with call parameters.

For the Basic head, FB SICS_BA is called as follows:

```
CALL "SICS_BA" , DB42
  ADDR          :=256
  DB_SCALE     :=22
```

7B Programming in SIMATIC STEP 7

```
CMD_IN           := "DB_SCALE_CS" . i_CMD_INPUT
SEL_PROC_VAL     := "DB_SCALE_CS" . b_SELECT_PROC_VAL
EXT_TARA        := "DB_SCALE_CS" . i_PRESET_TARE
CMD_INPR        := "DB_SCALE_CS" . bo_CMD_IN_PROGRESS
CMD_FOK         := "DB_SCALE_CS" . bo_CMD_FINISHED_OK
CMD_ERR         := "DB_SCALE_CS" . bo_CMD_ERR
CMD_ERR_C       := "DB_SCALE_CS" . b_CMD_ERR_CODE
REF_COUNT       := "DB_SCALE_CS" . b_INFO_REFRESH_COUNT
ACT_SEL_PROC_VAL := "DB_SCALE_CS" . b_SELECTED_PROC_VAL
PROC_VAL1       := "DB_SCALE_CS" . i_PROCESS_VALUE
SC_STATUS       := "DB_SCALE_CS" . w_SCALE_STATUS
ERR_MSG_C       := "DB_SCALE_CS" . b_OPR_ERR_MSG
FB_ERR          := "DB_SCALE_CS" . bo_FB_ERR
FB_ERR_C        := "DB_SCALE_CS" . b_FB_ERR_CODE
START_UP        := "DB_SCALE_CS" . bo_START_UP_IN_PROGRESS
CMD_EN          := "DB_SCALE_CS" . bo_CMD_TRIGGER
```

Figure 8-1 Call Parameters for FB SICS_BA

For the Standard, HF and CPU head, FB SICS_DR is called as follows:

```
CALL "SICS_DR" , DB41
  ADDR           := 256
  DB_SCALE       := 21
  DB_VECTOR      := 20
  CMD_IN         := "DB_SCALE_CS" . i_CMD_INPUT
  SEL_PROC_VAL   := "DB_SCALE_CS" . b_SELECT_PROC_VAL
  EXT_TARA       := "DB_SCALE_CS" . i_PRESET_TARE
  CMD_INPR       := "DB_SCALE_CS" . bo_CMD_IN_PROGRESS
  CMD_FOK        := "DB_SCALE_CS" . bo_CMD_FINISHED_OK
  CMD_ERR        := "DB_SCALE_CS" . bo_CMD_ERR
  CMD_ERR_C      := "DB_SCALE_CS" . b_CMD_ERR_CODE
  REF_COUNT      := "DB_SCALE_CS" . b_INFO_REFRESH_COUNT
  ACT_SEL_PROC_VAL := "DB_SCALE_CS" . b_SELECTED_PROC_VAL
  PROC_VAL1      := "DB_SCALE_CS" . i_PROCESS_VALUE
  SC_STATUS      := "DB_SCALE_CS" . w_SCALE_STATUS
  ERR_MSG_C      := "DB_SCALE_CS" . b_OPR_ERR_MSG
  FB_ERR         := "DB_SCALE_CS" . bo_FB_ERR
  FB_ERR_C       := "DB_SCALE_CS" . b_FB_ERR_CODE
  START_UP       := "DB_SCALE_CS" . bo_START_UP_IN_PROGRESS
  CMD_EN         := "DB_SCALE_CS" . bo_CMD_TRIGGER
```

Figure 8-2 Call Parameters for FB SICS_DR

8.5 Call Parameters for FB SICS...

The call parameters for FB SICS... are described in the following section. As supplied, the call parameters are defined as variables in the scale DB. It is possible to define the call parameters with other variables of the same type.

When calling FB SICS..., the number of the instance DB to be generated must be specified.

8.5.1 ADDR:= 256. Input, INT

For operation, SIWAREX CS requires 8 bytes in the input and output area of the SIMATIC CPU. The parameter ADDR must match the specification in HW Config.

8.5.2 DB_SCALE:= 21 or 22, Input, INT

A scale DB must be defined for every scale, and contains the parameters of the SIWAREX CS and the current actual values. The number of the DB can be freely selected. In the configuration package, DB21 (for HF and CPU head) and DB22 (for Basic and Standard head) have been specified as the scale DB. In addition, UDT21 and UDT22 are supplied as a template for the creation of blocks.

8.5.3 DB_VECTOR:= 20, Input, INT

(FB: SICS_DR for Standard, HF and CPU head only)

The content of the vector DB may not be modified. It only has to be loaded once for each SIMATIC CPU, regardless of the number of SIWAREX modules that are used. The number of the DB can be freely selected.

8.5.4 CMD_IN:= "DB_SCALE".i_CMD_INPUT, Input, INT

This input variable controls all commands, regardless of whether they involve the transfer of a data record (FB SICS_DR only) or the execution of a weighing task. The commands are described in chapter 6. This variable provides the command number and the command is triggered by the variable CMD_EN:= "DB_SCALE".bo_CMD_ENABLE (see chapter 8.5.19). FB SICS... does not delete the command number, but resets the trigger variable CMD_EN:= "DB_SCALE".bo_CMD_ENABLE after execution of the command.

8.5.5 EXT_TARA:= "DB_SCALE_CS".i_PRESET_TARE, Input, INT

With this input variable an external tare weight can be specified.

8.5.6 SELECT_PROC_VAL:= "DB_SCALE".b_SELECT_PROC_VAL, Input, BYTE

This input variable selects which process value is to appear in the PROC_VAL output.

- 0 – Gross/Net weight
- 1 – Tare weight
- 2 – Gross process value
- 3 – Net process value
- 4 – Tare weight process value
- 5 – Filtered ADC digit value
- 6 – Unfiltered ADC digit value
- 7 – Reserve

8.5.7 CMD_INPR:= "DB_SCALE".bo_CMD_IN_PROGRESS, Output, BOOL

The bit informs the user that a command is currently being processed.

8.5.8 **CMD_FOK:= "DB_SCALE".bo_CMD_FINISHED_OK, Output, BOOL**

The bit informs the user that his command has been executed with no errors (Command finished without errors). The bit is only set for one cycle (edge).

8.5.9 **CMD_ERR:= "DB_SCALE".bo_CMD_ERR, Output, BOOL**

The bit informs the user that a command has not been executed. The bit is only set for one cycle (edge). In the same cycle, the variable `CMD_ERR_C:= "DB_SCALE".b_CMD_ERR_CODE` can be used to evaluate the cause. The number is decoded in the table "Data and Operating Errors" in chapter 7.7. If no error code is specified, the error must be evaluated in `"DB_SCALE".b_FB_ERR_CODE`.

8.5.10 **CMD_ERR_C:= "DB_SCALE".b_CMD_ERR_CODE, Output, BYTE**

For commands not executed (Finished with errors), the error number is output here. The number output is decoded in the table "Data and Operating Errors" in chapter 7.7. The value remains in the output until the next error. The evaluation is to be performed when the set bit `CMD_ERR:= "DB_SCALE".bo_CMD_ERR` appears. If no error code is specified, the error must be evaluated in `"DB_SCALE".b_FB_ERR_CODE`.

8.5.11 **REF_COUNT:= "DB_SCALE".b_INFO_REFRESH_COUNT, Output, BYTE**

The current output values which are provided as output variables of the FB SIWA_CS are read cyclically by the FB across the peripheral range. SIWAREX CS internally updates the values at 20 ms intervals. Each update is given a number, which can be used as a time stamp in the SIMATIC CPU.

8.5.12 **ACT_SEL_PROC_VAL:= "DB_SCALE".b_SELECTED_PROC_VAL, Output, BYTE**

Display, which process value is currently output to PROCVAL, see also `SELECT_PROC_VAL`.

8.5.13 **PROC_VAL1:= "DB_SCALE".i_PROCESS_VALUE, Output, INT**

This variable normally outputs the gross weight or the net weight of the scale. The input variable `"DB_SCALE".b_SELECT_PROC_VAL` can be used to make the selection.

8.5.14 **SC_STATUS:= "DB_SCALE".w_SCALE_STATUS, Output, BYTE**

This variable always outputs the status of the scale (see chapter 5.7.1).

8.5.15 **ERR_MSG_C:= "DB_SCALE".b_OPR_ERR_MSG, Output, BYTE**

This variable outputs the asynchronous operating messages (see chapter 7.8).

8.5.16 **FB_ERR:= "DB_SCALE".bo_FB_ERR, Output, BOOL**

If an error has occurred during the processing of the function block itself, it is indicated by this variable.



Warning

If a processing error occurs for FB SICS... it must be assumed that the variables that have been output do not correspond with the actual status in the module.

8.5.17 **FB_ERR_C:= "DB_SCALE".b_FB_ERR_CODE, Output, BYTE**

This variable outputs the error number for FB SICS....

The following messages can be output:

- Bit 0 – DB_SCALE or DB_VECTOR are not available or are incorrect length, or SFB52/SFB53 is not available in the CPU
- Bit 1 – Error with internal call for SFC58 or SFC59, the value RET_VAL is entered in DW4 in the scale DB for a cycle
- Bit 2 – Error interpreting a data record / command, specified data record or command number is incorrect.
- Bit 3 – Lifebit error, SIWAREX CS not responding
- Bit 4 – Unable to read peripheral data in this cycle
- Bit 5 – Activated command aborted at restart
- Bit 6 – Reserved
- Bit 7 – Reserved



Warning

If a processing error occurs for FB SICS... it must be assumed that the variables that have been output do not correspond with the actual status in the module.

8.5.18 **START_UP:= "DB_SCALE".bo_START_UP_IN_PROGRESS, Output, BOOL**

Communication between the SIWAREX CS and the FB SICS... is synchronized when the SIWAREX CS module is restarted (normally when the SIMATIC CPU is started). The bit can be output for more than one cycle.

8.5.19 **CMD_EN:= "DB_SCALE".bo_CMD_ENABLE, Input, BOOL**

After entering the command number in the variable CMD_IN:= "DB_SCALE".i_CMD_INPUT, this bit is used to trigger execution of the command. To prevent the command from being triggered more than once, the bit should be created as an edge. After execution of the command, the FB SICS... resets the trigger variable CMD_EN:= "DB_SCALE".bo_CMD_ENABLE.

8.6 Allocation of Scale DB

The allocation of the scale DB for the HF/CPU and Basic/Standard heads is shown below. All components of the SIMATIC STEP 7 software for SIWAREX CS are produced in English.

Scale DB for FB SICS_DR

DB	DR	Name	Type	Default	Comment
0.0	0.0	i_DB_Length	INT	222	Length of the DB
2.0	2.0	i_MaxLifeBitCyc	INT	500	Lifebit check
4.0	4.0	i_SFC_ERR_C	WORD	W#16#0	Communication error RET_VAL of sfc58/59
6.0	6.0	i_CMD_INPUT	INT	0	Command code input
8.0	8.0	bo_CMD_TRIGGER	BOOL	FALSE	Command trigger
8.1	8.1	bo_CMD_IN_PROGRESS	BOOL	FALSE	Command in progress
8.2	8.2	bo_CMD_FINISHED_OK	BOOL	FALSE	Command finished ok
8.3	8.3	bo_CMD_ERR	BOOL	FALSE	Command error length
9.0	9.0	b_CMD_ERR_CODE	BYTE	B#16#0	Command error code
10.0	10.0	i_PRESET_TARE	INT	0	Prest tare value
12.0	12.0	b_SELECT_PROC_VAL	BYTE	B#16#0	Selection of the process value for output
13.0	13.0	b_SELECTED_PROC_VAL	BYTE	B#16#0	Selection of the process value for output
14.0	14.0	i_PROCESS_VALUE	INT	0	Process value
16.0	16.0	b_INFO_REFRESH_COUNT	BYTE	B#16#0	Refresh counter info
18.0	18.0	w_SCALE_STATUS	WORD	W#16#0	Scale status info
20.0	20.0	b_OPR_ERR_MSG	BYTE	B#16#0	Operation error bits
21.0	21.0	bo_FB_ERR	BOOL	FALSE	Error in function block length
22.0	22.0	b_FB_ERR_CODE	BYTE	B#16#0	Errorcode for function block
23.0	23.0	bo_START_UP_IN_PROGRESS	BOOL	FALSE	Start up of function block in progress
	24.0	s_CMD1	STRUCT		Command input 1
24.0	0.0	i_CMD1_Code	INT	0	Command code
26.0	2.0	bo_CMD1_Trigger	BOOL	FALSE	Command trigger
26.1	2.1	bo_CMD1_InProgress	BOOL	FALSE	Command in progress
26.2	2.2	bo_CMD1_FinishedOk	BOOL	FALSE	Command finished ok
26.3	2.3	bo_CMD1_FinishedError	BOOL	FALSE	Command finished with error
	=4		END_STRUCT		
	28.0	s_CMD2	STRUCT		Command input 2
28.0	0.0	i_CMD2_Code	INT	0	Command code
30.0	2.0	bo_CMD2_Trigger	BOOL	FALSE	Command trigger
30.1	2.1	bo_CMD2_InProgress	BOOL	FALSE	Command in progress
30.2	2.2	bo_CMD2_FinishedOk	BOOL	FALSE	Command finished ok
30.3	2.3	bo_CMD2_FinishedError	BOOL	FALSE	Command finished with error
	=4		END_STRUCT		
	32.0	s_CMD3	STRUCT		Command input 2
32.0	0.0	i_CMD3_Code	INT	0	Command code
34.0	2.0	bo_CMD3_Trigger	BOOL	FALSE	Command trigger
34.1	2.1	bo_CMD3_InProgress	BOOL	FALSE	Command in progress

34.2	2.2	bo_CMD3_FinishedOk	BOOL	FALSE	Command finished ok
34.3	2.3	bo_CMD3_FinishedError	BOOL	FALSE	Command finished with error
	=4		END_STRUCT		
36.0	36.0	w_DB_RES92	WORD	W#16#0	
38.0	38.0	w_DB_RES93	WORD	W#16#0	
40.0	40.0	w_DB_RES94	WORD	W#16#0	
42.0	42.0	w_DB_RES95	WORD	W#16#0	
44.0	44.0	w_DB_RES96	WORD	W#16#0	
46.0	46.0	w_DB_RES97	WORD	W#16#0	
48.0	48.0	w_INT_USE	WORD	W#16#0	Word for internal use of FB SICS...
	50.0	s_JUST_DAT	STRUCT		DR3: Calibration parameters
50.0	0.0	w_CALIB_DIGITS0	WORD	W#16#0	Calibration digits for 0
52.0	2.0	w_CALIB_DIGITS1	WORD	W#16#EA60	Calibration digits for 1
54.0	4.0	w_CALIB_DIGITS2	WORD	W#16#0	Calibration digits for 2
56.0	6.0	i_CALIB_WEIGHT1	INT	2000	Calibration weight for 1
58.0	8.0	i_CALIB_WEIGHT2	INT	0	Calibration weight for 2
60.0	10.0	b_SIGNAL_RANGE	BYTE	B#16#2	Input range (1=1mV/v, 2=2mV/V, 4=4mV/V)
61.0	11.0	b_FILTER_TYPE	BYTE	B#16#0	Filter type signal filter (only 0 allowed)
62.0	12.0	b_FILTER_FREQ	BYTE	B#16#4	Filter low pass frequency
63.0	13.0	b_FILTER_DEPTH	BYTE	B#16#F	Filter depth of average value filter (0...FF)
64.0	14.0	s_SCALE_ID	STRING[10]	'SIWAREX XX'	Scale identity
76.0	26.0	i_MIN_WR	INT	20	Minimum for weighing range WR
78.0	28.0	i_MAX_WR	INT	2000	Maximum for weighing range WR
80.0	30.0	i_INCREMENT_WR	INT	1	Digital increment for weighing range
82.0	32.0	i_WEIGHT_ST_STILL	INT	10	Stand still weight
84.0	34.0	t_TIME_ST_STILL1	TIME	T#1S	Stand still time in ms
88.0	38.0	b_DEC_POINT	BYTE	B#16#2	Decimal point for remote display
89.0	39.0	b_ZERO_NEG_VALUE	BYTE	B#16#1	Zeroing negative range (% of WR)
90.0	40.0	b_ZERO_POS_VALUE	BYTE	B#16#3	Zeroing positive range (% of WR)
91.0	41.0	b_TARA_MAX	BYTE	B#16#64	Tara range (% of WR)
92.0	42.0	i_Reserve	INT	0	Reserve
94.0	44.0	s_LEGAL_TRADE	STRING[4]	'----	OIML or no ----
100.0	50	s_WEGHT_UNIT	STRING[4]	'kg '	Unit for weight
	=56		END_STRUCT		
	106.0	s_LIMIT_PARA	STRUCT		DR4: Limit parameters
106.0	0.0	i_LIMIT1_ON	INT	400	Value for limit 1 on
108.0	2.0	i_LIMIT1_OFF	INT	220	Value for limit 1 off
110.0	4.0	i_LIMIT2_ON	INT	1000	Value for limit 2 on
112.0	6.0	i_LIMIT2_OFF	INT	980	Value for limit 2 off
114.0	8.0	bo_LIMIT1_PARA	BOOL	FALSE	Limit 1 beased on gross weight (0) or net weight (1)
114.1	8.1	bo_LIMIT2_PARA	BOOL	FALSE	Limit 2 beased on gross weight (0) or net weight (1)
115.0	9.0	b_Reserve	BYTE	B#16#0	
	=10		END_STRUCT		
	116.0	s_MODUL_INFO_DATA	STRUCT		DR9: Module information data
116.0	0.0	s_MODUL_NAME	STRING[10]	''	Name of the module
128.0	12.0	s_ORDER_NUM	STRING[20]	''	Order number (MLFB)

7BProgramming in SIMATIC STEP 7

150.0	34.0	w_VERSION_HW	WORD	W#16#0	Hardware version
152.0	36.0	s_VERSION_FW	STRING[4]	,	Firmware version
158.0	42.0	w_CRC_CHECK	WORD	W#16#0	CRC checksum of the application software
	=44		END_STRUCT		
	160.0	s_TARE_CONTROL	STRUCT		DR15: Tare control
160.0	0.0	i_TARE_VALUE	INT	0	Tare set value
	=2		END_STRUCT		
	162.0	s_INTERNAL_PROC_VAL	STRUCT		DR26: Internal process values
162.0	0.0	w_CRC_CHECK	WORD	W#16#0	CRC checksum of the application software
164.0	2.0	b_Reserve	BYTE	B#16#0	
165.0	3.0	bo_PRESET_TARA	BOOL	FALSE	Tare value is preset
166.0	4.0	d_TARA_X_100	DINT	L#0	Actual tare value x 100
170.0	8.0	d_ZERO_X_100	DINT	L#0	Actual zero value x 100
	=12		END_STRUCT		
	174.0	s_PROCESS_VALUES	STRUCT		DR30: Process values
174.0	0.0	w_CRC_CHECK	WORD	W#16#0	CRC checksum of the application software
176.0	2.0	bo_STA_WRI_PROT	BOOL	FALSE	Status write protection on
176.1	2.1	bo_STA_WR_MIN	BOOL	FALSE	Status weighing range minimum
176.2	2.2	bo_STA_Reserve1	BOOL	FALSE	Status reserve
176.3	2.3	bo_STA_Reserve2	BOOL	FALSE	Status reserve
176.4	2.4	bo_STA_Reserve3	BOOL	FALSE	Status reserve
176.5	2.5	bo_STA_Reserve4	BOOL	FALSE	Status reserve
176.6	2.6	bo_STA_Reserve5	BOOL	FALSE	Status reserve
176.7	2.7	bo_STA_ERROR_ON	BOOL	FALSE	Status operational error on
177.0	3.0	bo_STA_LIMIT1_ON	BOOL	FALSE	Status limit 1 is on
177.1	3.1	bo_STA_LIMIT2_ON	BOOL	FALSE	Status limit 2 is on
177.2	3.2	bo_STA_TARED	BOOL	FALSE	Status scale tared
177.3	3.3	bo_STA_TARED_BY_MANUAL	BOOL	FALSE	Status scale tared by manual
177.4	3.4	bo_STA_MAX_9E	BOOL	FALSE	Status max plus 9 e
177.5	3.5	bo_STA_025_D_ZERO	BOOL	FALSE	Status zero 0.25 d
177.6	3.6	bo_STA_ST_STAND_SCALE_ON	BOOL	FALSE	Status stand still 1 on
177.7	3.7	bo_STA_SCALE_CALIBRATED	BOOL	FALSE	Status scale ist calibrated
178.0	4.0	b_OPR_ERR_MSG	BYTE	B#16#0	Operation error bits
179.0	5.0	b_Reserve	BYTE	B#16#0	
180.0	6.0	i_GROSS_WEIGHT_PROC	INT	0	Actual weight process value gross
182.0	8.0	i_NET_WEIGHT_PROC	INT	0	Actual weight process value netto
184.0	10.0	i_TARE_WEIGHT_PROC	INT	0	Actual weight process value tare
186.0	12.0	i_GROSS_NET_VALUE	INT	0	Actual weihgt process legal value
188.0	14.0	d_GROSS_NET_VALUE_10X	DINT	L#0	Actual weight process legal value x 10
192.0	18.0	i_TARE_VALUE	INT	0	Actual weight tare process legal value
194.0	20.0	i_ADC_DIGIT	INT	0	Actual ADC digit value before filtering
196.0	22.0	i_ADC_DIGIT_FILTER	INT	0	Actual ADC digit value after filtering
198.0	24.0	s_WEIGHT_ASCII	STRING[14]	"	Actaul weight as ASCII string
214.0	40.0	i_MILISEC	INT	0	Actual runtime milliseconds
216.0	42.0	b_SECONDS	BYTE	B#16#0	Actual runtime seconds
217.0	43.0	b_MINUTE	BYTE	B#16#0	Actual runtime minutes
218.0	44.0	i_HOURS	INT	0	Actual runtime hours

	=46		END_STRUCT	
220.0	220.0	i_DB_Length1	INT	222

Table 8-1 Allocation of Scale DB for FB SICS_DR

Scale_DB for FB SICS_BA					
DB	DR	Name	Type	Default	Comment
0.0	0.0	length_DB_Length	INT	52	Length of the DB
2.0	2.0	length_MaxLifeBitCyc	INT	500	Lifebit check
4.0	4.0	i_SFC_ERR_C	WORD	W#16#0	Communication error RET_VAL of sfc58/59
6.0	6.0	i_CMD_INPUT	INT	0	Command code input
8.0	8.0	bo_CMD_TRIGGER	BOOL	FALSE	Command trigger
8.1	8.1	bo_CMD_IN_PROGRESS	BOOL	FALSE	Command in progress
8.2	8.2	bo_CMD_FINISHED_OK	BOOL	FALSE	Command finished ok
8.3	8.3	bo_CMD_ERR	BOOL	FALSE	Command error length
9.0	9.0	b_CMD_ERR_CODE	BYTE	B#16#0	Command error code
10.0	10.0	length_PRESET_TARE	INT	0	Preset tare value
12.0	12.0	b_SELECT_PROC_VAL	BYTE	B#16#0	Selection of the process value for output
13.0	13.0	b_SELECTED_PROC_VAL	BYTE	B#16#0	Selection of the process value for output
14.0	14.0	length_PROCESS_VALUE	INT	0	Process value
16.0	16.0	b_INFO_REFRESH_COUNT	BYTE	B#16#0	Refresh counter info
18.0	18.0	w_SCALE_STATUS	WORD	W#16#0	Scale status info
20.0	20.0	b_OPR_ERR_MSG	BYTE	B#16#0	Operation error bits
21.0	21.0	bo_FB_ERR	BOOL	FALSE	Error in function block length
22.0	22.0	b_FB_ERR_CODE	BYTE	B#16#0	Error code for function block
23.0	23.0	bo_START_UP_IN_PROGRESS	BOOL	FALSE	Start up of function block in progress
	24.0	s_CMD1	STRUCT		Command input 1
24.0	0.0	length_CMD1_Code	INT	0	Command code
26.0	2.0	bo_CMD1_Trigger	BOOL	FALSE	Command trigger
26.1	2.1	bo_CMD1_InProgress	BOOL	FALSE	Command in progress
26.2	2.2	bo_CMD1_FinishedOk	BOOL	FALSE	Command finished ok
26.3	2.3	bo_CMD1_FinishedError	BOOL	FALSE	Command finished with error
	=4		END_STRUCT		
	28.0	s_CMD2	STRUCT		Command input 2
28.0	0.0	i_CMD2_Code	INT	0	Command code
30.0	2.0	bo_CMD2_Trigger	BOOL	FALSE	Command trigger
30.1	2.1	bo_CMD2_InProgress	BOOL	FALSE	Command in progress
30.2	2.2	bo_CMD2_FinishedOk	BOOL	FALSE	Command finished ok
30.3	2.3	bo_CMD2_FinishedError	BOOL	FALSE	Command finished with error
	=4		END_STRUCT		
	32.0	s_CMD3	STRUCT		Command input 2
32.0	0.0	i_CMD3_Code	INT	0	Command code
34.0	2.0	bo_CMD3_Trigger	BOOL	FALSE	Command trigger
34.1	2.1	bo_CMD3_InProgress	BOOL	FALSE	Command in progress
34.2	2.2	bo_CMD3_FinishedOk	BOOL	FALSE	Command finished ok
34.3	2.3	bo_CMD3_FinishedError	BOOL	FALSE	Command finished with error

7B Programming in SIMATIC STEP 7

DB	DR	Name	Type	Default	Comment
	=4		END_STRUCT		
36.0	36.0	w_DB_RES92	WORD	W#16#0	
38.0	38.0	w_DB_RES93	WORD	W#16#0	
40.0	40.0	w_DB_RES94	WORD	W#16#0	
42.0	42.0	w_DB_RES95	WORD	W#16#0	
44.0	44.0	w_DB_RES96	WORD	W#16#0	
46.0	46.0	w_DB_RES97	WORD	W#16#0	
48.0	48.0	w_INT_USE	WORD	W#16#0	Word for internal use of FB SICS...
50.0	50.0	length_DB_Length1	INT	52	

Table 8-2 Allocation of Scale DB for FB SICS_BA

9 Setting the Scale – SIWATOOL CS

9.1 General

You can use the SIWATOOL CS program to set the scale without commissioning of the SIMATIC automation system.

This program is included in the configuration package supplied.

The first step is to install the program (catalog SIWATOOL_CS). It requires less than 50 MB on the hard disk.

9.2 Windows and Functions in SIWATOOL CS

The program windows are structured in such a way as to simplify navigation around the SIWAREX CS parameters. The left-hand section contains an overview of the parameters in a tree structure. The grouping of the parameters corresponds to the various activities which may be necessary during configuration, commissioning, testing and servicing.

Each branch of the tree structure corresponds to a data record in SIWAREX CS. A data record summarizes several parameters. In the right-hand window, the parameters in a data record can be edited in index card format.

The first card in a box is set up as an information sheet. This info sheet describes which tasks can be processed using the parameters from the selected data record. For sending, receiving and transferring, the entire data record is always processed, not just one index card.

9.3 Offline Configuration

All scale parameters can be processed and stored without the SIWAREX CS. This reduces the commissioning time.

The parameters for more than one scale can be prepared in the office and only have to be transferred to the SIWAREX CS during commissioning.

Data from one scale that is currently in operation can be read and used in the commissioning of another scale.

9.4 Online Operation

To switch to online operation, the PC must be connected to SIWAREX CS using the SIWATOOL cable (see [Accessories](#)). The PC's COM interface can be set up in the communication menu.

All parameters can be changed in online operation. A message window shows the current content of the message buffer on the SIWAREX CS. The current process values can be viewed in various windows. For testing purposes, all commands can be sent to the SIWAREX CS.

All data can be read out and stored as a file or printed for archiving purposes.

8B Setting the Scale – SIWATOOL CS



Warning

All data can be edited in the module in online operation. The changes are not automatically integrated into the corresponding scale data block. You can decide whether data comparison is necessary and, if so, initiate it.

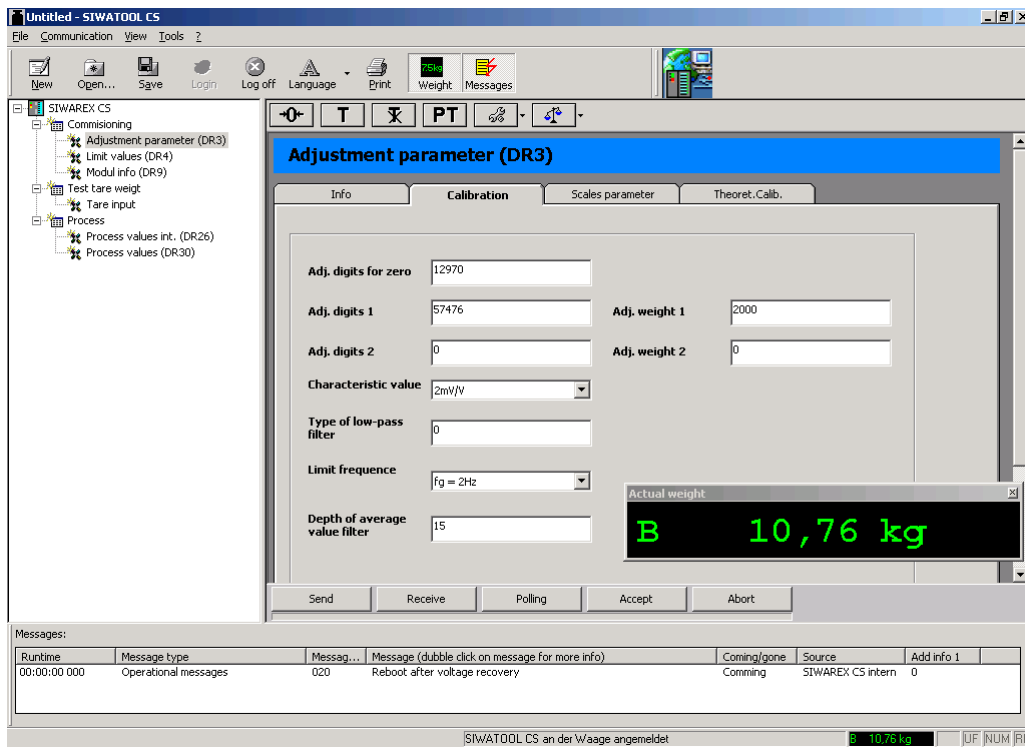

Figure 9-1 SIWATOOL CS Window Assignment

9.5 Help

After clicking on a data record in the left-hand program window, the "Info" card can be selected in the right-hand program window. A description of the affect of the data record on the behavior of the scale is shown in a white area.

After selecting a card, a segment of the corresponding data record is shown in the form of input and output fields. In addition to the parameter designation, the Tool Tips can also be helpful in remembering the meanings of certain parameters (text is displayed if the mouse pointer is positioned over a field).

Clicking on the menu option "Help", calls up the "SIWAREX CS" manual. Installation of Acrobat Reader is necessary to read the manual.

10 Calibrating Applications

10.1 General Information



Attention

Scales subject to calibration may only be certified by a calibration expert or qualified official.

Preparation

Prior to the actual certification by the calibration expert, the operator of the scale should make the preparations described below:

Start SIWAREX CS

- Adjust the scale as described in the device manual
 - Check all of the relevant points under (1), (2), (3) and (4).
- (1) = European Regulations ER (90/384/EEC) on non-automatic weighing instruments
- (2) = European Standard EN 45 501 for non-automatic weighing instruments
- (3) = Run through checklist from calibration set (accessory).

Calibration sticker

The calibration sticker is found in the calibration set which is available as an accessory.

Certification of SIWAREX CS

The calibrated scale is certified by an authorized person.

Certification stamp on SIWAREX CS

After activation of write protection (jumper across connection points 1 and 5) the terminal cover is fitted and the certification stamp and calibration mark are attached by the official.

10.2 Sealing in Calibrating Application

Calibration certification is followed by mechanical and data sealing of the module.

On the terminal module, a jumper to the parameter block can be inserted. If this jumper is inserted, the following operations are blocked on every interface:

- Execution of adjustment commands that influence the scale characteristic curve.
- Transfer of calibration parameters to the scale (data record DS3)
- Transfer of internal process values (DS26) to the scale

In calibrating operation, the jumper to the parameter block must be fixed in place before the terminal cover is attached and sealed (connection 1-5). If the jumper is inserted, the "Parameter input blocked" LED on the SIWAREX CS is illuminated



Attaching the terminal cover simultaneously ensures that the weighing module cannot be replaced. The terminal module is thus permanently connected to the SIWAREX CS evaluation unit. The terminal cover can be fixed in place at connection 11 on the terminal module by sliding it through a small hole in the terminal cover.

Sealing involves sticking the identification plate onto the terminal cover; its design is such that it is stuck over the access hole, which is therefore inaccessible.

To identify the scale and its calibration values a conventional mechanical identification plate should be stuck onto the terminal cover for the evaluation electronics. On the right-hand side of the evaluation electronics unit is a rating plate with other manufacturer's specifications. The identification plate is destroyed if removed. After calibration, the green "M" should be attached to the terminal cover. The calibration values are repeated on a label strip in the main S102 display.

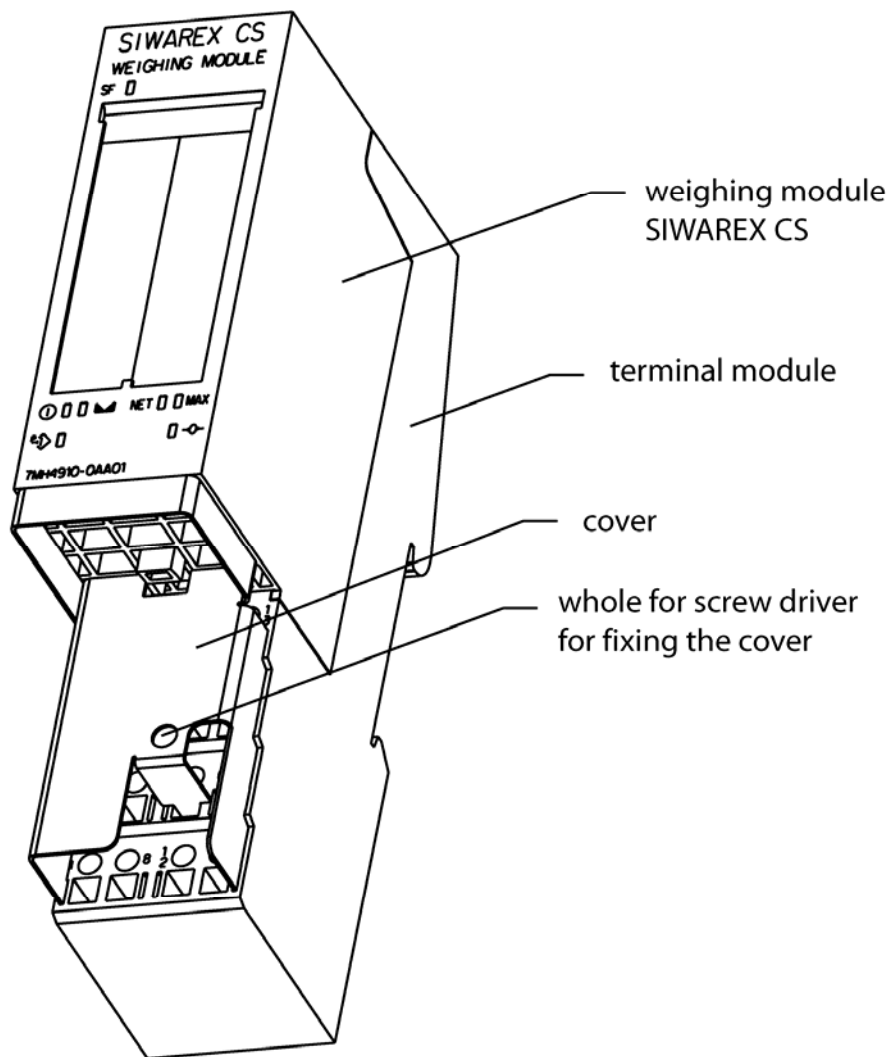

Figure 10-1 Terminal Cover in Calibrating Application

Note:

In calibrating application, only a terminal module with screwed contacts may be used for the SIWAREX CS.

9BCalibrating Applications

After calibration certification, the following adhesive labels should be attached for security:

- Between bottom of housing and cover of SIWAREX CS to prevent unauthorized opening
- If using a SIWAREX IS Ex interface in accordance with test certificate D09-01.38
- On the S102 display unit in accordance with test certificate (still in progress for PTB).

Security stamps should also be attached on the junction box (SIWAREX JB) if several load cells are connected. After calibration certification, the connection points for connection to the PC remain accessible.

The SIWAREX CS has a display facility with 10x higher resolution. This weight value is displayed instead of the main display (also in ASCII weight DS30) for a duration of 5 seconds after triggering of a command.

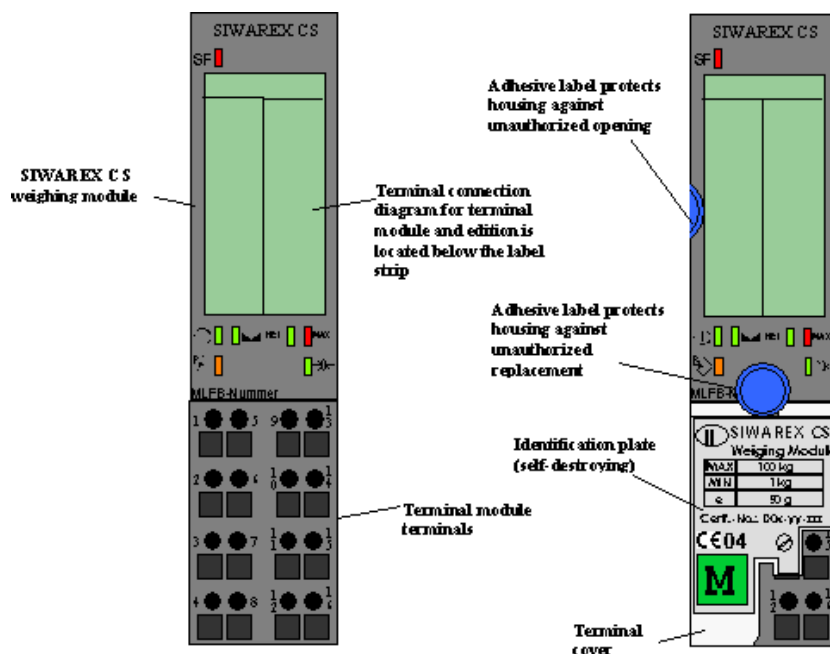

Figure 10-2 Identification Plate, Calibration Mark and Security Labels.

The unit of weight can be freely specified in the DS3 calibration parameters. Four ASCII characters are provided for this purpose. The unit of weight is automatically shown in the calibration ASCII weight in DS30. On the S102 remote display, the unit of weight must be attached before sealing.

11 Accessories

There are essential and optional accessories for the SIWAREX CS.

The essential accessories are indicated in the following table.

SIWAREX CS Weighing Electronics for SIMATIC S7 ET 200S, Weight 0.2 kg for connection of a scale	7MH4 910-0AA01
SIWAREX CS device manual • German, English, Italian, Spanish, French, Russian, Chinese	Free download from Internet
SIWAREX CS Getting Started – STEP 7 software for sample application	Free download from Internet
Calibration set for SIWAREX CS For verification of up to 5 scales comprising: 1 x inscription foil for labeling 1 x protection foil 5 x cover for terminal block 10 x EC verification mark (black M on green background) Guidelines for verification, verification certificates and approvals, adaptable label SIWAREX CS Manual	7MH4 910-0AY10
Configuration package SIWAREX CS for SIMATIC –S7, from Version V5.4 on CD ROM • PC parameterization software SIWATOOL (several languages) • Example programs • SIWAREX CS device manuals on CD (in German, English, Italian, French, Russian, Chinese)	7MH4 910-0AK01
SIWATOOL connecting cable for SIWAREX CS with serial PC interface Installation materials (essential)	7MH4 607-8CA

10B Accessories

Terminal module **6ES7 193-4CG20-0AA0**
or similar TM-E 30mm wide (required for each SIWAREX module)

Shielding contact rail **6ES7 193-4GA00-0AA0**
Content 5 units

Shielding connection clamp **6ES7 193-4GB00-0AA0**
Content: 5 units

Note:

One shielding connection clamp is required for each of the following:

- Scale connection and
- TTY interface or
- RS 232 interface

N busbar, tin plated **8WA2842**
3x10mm 1.5m long

Feed terminal for N busbar **8WA2868**

Other components for the ET 200S decentralized peripheral system are listed in the CA01 catalog

Remote displays (optional)

The remote digital displays can be connected directly to the SIWAREX CS via a TTY interface. Compatible remote displays:

S102

Siebert Industrieelektronik GmbH
Postfach 1180
D-66565 Eppelborn
Tel.: 06806/980-0
Fax: 06806/980-999
Internet: <http://www.siebert.de>

For detailed information, please contact the manufacturer.

Optional accessories

SIWAREX JB connection and distribution box **7MH4 710-1BA**
for parallel connection of load cells

SIWAREX EB expansion box **7MH4 710-2AA**
for extending load cell cables

Ex interface, Type SIWAREX Pi **7MH4 710-5AA**

without ATEX certification

for intrinsically safe connection of load cells, suitable for SIWAREX CS, U, M, FTA and P weighing modules.

UL and FM certification

SIWAREX Pi Ex interface device manual

C71000-T5974-C29

Ex interface, Type SIWAREX IS

with ATEX certification

for intrinsically safe connection of load cells, inc. device manual, suitable for SIWAREX CS, U, M, FTA and P weighing modules.

with short-circuit current < DC 199 mA

7MH4 710-5BA

with short-circuit current < DC 137 mA

7MH4 710-5CA

Cables (optional)

Cable Li2Y 1 x 2 x 0.75 ST + 2 x (2 x 0.34 ST) – CY

7MH4 702-8AG

for connection of SIWAREX CS, U, M, P, A to connection and junction box (JB), expansion box (EB) or Ex interface (Ex-I) and between two JB's, for stationary installation,

occasional bending is possible

10.8 mm exterior diameter

for ambient temperature –20 to +70°C

Cable Li2Y 1 x 2 x 0.75 ST + 2 x (2 x 0.34 ST) – CY, blue cover 7MH4 702-8AF

Connection of connection and junction box (JB) or expansion box (EB) in area with risk of explosion and Ex interface (Ex-I), for stationary installation,

occasional bending is possible,

blue PVC insulating sleeve, approx. 10.8 mm exterior diameter

for ambient temperature –20 to +70°C

Cable LiYCY 4 x 2 x 0.25 mm²

7MH4 407-8BD0

for TTY (2 cable pairs connected in parallel), for connection of remote display

12 Technical Data

12.1 Power Supply 24 V

An isolated function low voltage (in accordance with EN60204-1) is to be ensured by the system power supply.

Rated voltage	DC 24 V feed from PM-E power module
Static upper / lower limits	DC 20.4 V/28.8V
Dynamic upper / lower limits	DC 18.5 V/30.2 V
Non-periodic over-voltages	DC 35 V for 500 msec with a recovery time of 50 sec.
Max. current consumption	150 mA
Typical module power loss	5 W

Table 12-1 Data: Power Supply 24 V

12.2 Power Supply from ET 200S Backplane Bus

Power consumption from ET 200S backplane bus	Typical < 10 mA
--	-----------------

Table 12-2 Data: Power Supply from ET 200S Backplane Bus

12.3 Load Cell Connection

EU type certification as non-automatic weighing instrument, class III	2000 d (pi = 0.4)
Precision with Ex-i interface	2000 d (pi = 0.4)
Error limit conforming to DIN1319-1 from measurement range end value at 20 °C \pm 10 K	\leq 0.05 %
Refresh rate internal / external	50 Hz
Internal resolution	65,535 parts
3 measuring ranges	0 to 1 mV/V 0 to 2 mV/V 0 to 4 mV/V
Max. distance to load cell (calibration)	1000 m (500 m)**
Max. distance between load cell and Ex-I interface in Ex area	150/500 m for gas group IIC 1000 m for gas group IIB (see SIWAREX IS device manual)
Lowest permitted input signal for a calibration value in calibrating operation	\geq 1.5 μ V/e
Load cell power	
Voltage	Typical DC 6 V *
Maximum current	68 mA
Permitted load cell resistance without Ex-I interface with feed from SIWAREX CS	Input resistance > 87 Ω Output resistance < 4010 Ω
Permitted load cell resistance with Ex-i-Interface	Input resistance > 87 Ω Output resistance < 4010 Ω

Permitted load cell resistance without Ex-I interface with external feed (24V isolated) via terminals 9 and 13	Input resistance > 40 Ω Output resistance < 4010 Ω
Monitor for sensor inputs	Typical ≥ 5.4 V Hysteresis 0.2 V
Response time for sensor line monitor	≤ 1 s
Common mode rejection CMRR @50 Hz	Typical 120 dB
Low pass filter limit frequency	0.05...5 Hz
Measured value filtering for average value filter	2...255 values (20 ms)
Isolation	500 V (DC)

* Values apply to module output

**When using recommended cables (accessories)

Table 12-3 Data: Load Cell Connection

12.4 RS 232C Interface

Baud rate	9600 baud
Data bits	8
Parity	Even
Stop bits	1
Max. distance	15 m
Signal level	Conforms to EIA-RS232C
Isolation	500 V (DC)

Table 12-4 Data: RS 232C Interface

12.5 TTY Interface

Operating mode	Passive and unidirectional, i.e. transmitter only (TxD)
Baud rate	9600 baud
Data bits	8
Parity	Even
Stop bits	1
Max. line length (@ 20 mA)	125 m
Isolation	500 V (DC)
Transmitter voltage drop	< 2 V
Max. loop current	25 mA

Table 12-5 Data: TTY Interface

12.6 Dimensions and Weight

Dimensions W x H x D	30 x 80 x 50 mm
Weight	75 g

Table 12-6 Data: Dimensions and Weight

12.7 Ambient Conditions

The SIWAREX CS is designed to be used in SIMATIC ET 200S systems under the following conditions.

Usage conditions in accordance with IEC 60721:

Operation: IEC60721-3-3
Stationary use, weatherproof
Class 3M3, 3K3

Storage/Transport: IEC 60721-3-2
Transport packaged, no condensation
Class 2M2, 2K4

For use in extreme operating conditions (e.g. heavy dust, acidic moisture or gasses etc.), additional measures are to be taken such as B. Encapsulation.

Table 12-7 Data: Ambient Conditions

12.8 Mechanical Requirements and Data

Testing	Standards	Test values
Vibration In operation	IEC 60068-2-6	<u>Testing Fc</u> 10 ... 58 Hz: 0.075 mm movement 58 ... 150 Hz: 9.8 m/s ² 10 cycles per axis 1 octave / min.
Shock in operation	IEC 60068-2-27	<u>Test Ea</u> 150 m/s ² , Half sinus Duration: 11 ms Number: 3 per axis each in neg. and pos. direction
Vibration during transport	IEC 60068-2-6	<u>Testing Fc</u> 5 ... 9 Hz: 3.5 mm movement 9 ... 500 Hz: 9.8 m/s ² 10 cycles per axis 1 octave / min.
Shock during transport	IEC 60068-2-29	<u>Testing Eb</u> 250 m/s ² , Half sinus Duration: 6 ms Number: 1000 per axis each
Free fall	IEC 68000-2-32	<u>Testing Ed</u> Height of fall 1m





Table 12-8 Data: Mechanical Requirements

12.9 Electrical, EMC and Climatic Requirements

12.9.1 Electrical Protection and Safety Requirements

Note:

The currently valid approvals for SIWAREX CS can be found on the SIWAREX CS rating plate.

	<p>Directives: 89/384/EEC "Non-automatic weighing instruments" 2004/108/EC "Electromagnetic Compatibility" 94/9/EC "Explosion protection"</p> <p>Note: Further information on EC directives can be found in the product documentation accompanying every SIWAREX CS.</p>
 <p>HAZ. LOC.</p>	<p>Underwriters Laboratories Inc. to UL 508 (Industrial Control Equipment) CSA C22.2 No. 142 (Process Control Equipment) UL 1604 (Hazardous Location) CSA-213 (Hazardous Location) APPROVED for use in Class I, Division 2, Group A, B, C, D Tx; Class I, Zone 2, Group IIC Tx</p>
	<p>Factory Mutual Research (FM) to Approval Standard Class Number 3611, 3600, 3810 APPROVED for use in Class I, Division 2, Group A, B, C, D T4; Class I, Zone 2, Group IIC T4</p>
	<p>Explosion protection to EN 60079-15: 2005 (Electrical apparatus for potentially explosive atmospheres; Type of protection "n") Class II 3 G Ex nA II T4</p> <p>Note: For use of the SIWAREX CS in areas with a risk of explosion, the important information in the "ET 200S Decentralized Peripheral System" manual must be adhered to!</p>

11B Technical Data

The SIWAREX CS meets the following requirements:

Requirement met	Standards	Comments
Safety regulations	EN60204; DIN VDE 0113; IEC 61131-2; IEC61010-1, UL 508; CSA C22.2 Nr.142; FM class I, Div.2; UL/CSA	UL-/CSA-/FM Zone 2 certification upon request
Protection class	Class I to IEC 60536	
IP protection	IP 20 to IEC 60529	<ul style="list-style-type: none"> • Protection against contact with standard test fingers • Protection against foreign bodies with diameters above 12.5 mm • No special protection against water
Air and creepage distances	IEC 61131	Surge category II Pollution degree 2 Circuit board material IIIa Circuit track spacing 0.5 mm
Insulation resistance	IEC 61131-2:	The insulation resistance was demonstrated with a test voltage of 500V in the type test.
Material	SN 36350 (3.93)	

Table 12-9 Data: Electrical Protection and Safety Requirements

12.9.2 Electromagnetic Compatibility

Spurious transmission (industrial use): EN 61000-6-4		
Comments	Standard	Limit values
Emission of radio interference (electromagnetic fields)	EN 61000-6-4	EN 55011 Class A, Group 1 30 – 230 MHz: < 40dB(μV/m) Q 230-1000MHz: < 47dB(μV/m) Q
Emission on power supply lines	EN 61000-6-4	EN 55011 Class A, Group 1 EN 55014

Interference immunity (industrial use): EN 61000-6-2		
Comments	Standard	Degree of severity
Burst pulses on power supply lines:	IEC 61000-4-4 IEC 61131-2 NAMUR NE 21	2 kV
Burst pulses on data and signal lines:	IEC 61000-4-4 IEC 61131-2 NAMUR NE 21	1 kV (<i>RS232 interface</i>) 2 kV (remaining data and signal lines)
Electrostatic discharge (ESD)	IEC 61000-4-2 NAMUR NE 21	6 kV

Interference immunity (industrial use): EN 61000-6-2		
Comments	Standard	Degree of severity
Electrostatic air discharge (ESD)	IEC 61000-4-2 NAMUR NE 21	8 kV
Surge on power supply lines	IEC 61000-4-5 NAMUR NE 21 IEC 61131-2	± 2 kV unsym.* ± 1 kV sym.*
Surge on data and signal lines:	IEC 61000-4-5 NAMUR NE 21 IEC 61131-2	± 1 kV unsym.* (to cable shielding)
HF irradiation (electromagnetic fields)	IEC 61000-4-3 IEC 61131-2 NAMUR NE 21	26 MHz to 1000 MHz: Up to 10 V/m (80% AM at 1 kHz) 900 MHz and 1.89GHz: Up to 10 V/m (50% PM) 2.0 GHz – 2,7 GHz : 1V/m
HF current feed Data, signal and power supply lines	IEC 61000-4-6 IEC 61131-2 NAMUR NE 21	9 kHz – 80 MHz 10V (80% AM 1 kHz)

Table 12-10 Data: Electromagnetic Compatibility

* An external protection element should be fitted to meet the requirement (e.g.: Blitzductor VT AD24V, from Dehn&Söhne)

Attention

This is a class A device. In residential areas, this device can cause radio interference. In such areas, users must take suitable measures (e.g.: use in 8MC cabinets).

12.9.3 Climatic Requirements

Climatic requirements		
Comments	Environmental conditions	Application range
Operating temperature: Horizontal installation in ET 200S Other installation positions in ET 200S Calibrating operation	-10 to +60 °C -10 to +40 °C -10 to +40 °C	The ET 200S standard module groups may not be operated below 0°C
Storage and transport temperature	-40 to +70 °C	
Relative humidity	15 to 95 %	Without condensation, corresponds to relative humidity (RH) exposure level 2 in accordance with DIN IEC 61131-2
Air pressure	from 1080 to 660 hPa	corresponds to an altitude of -1000 to 3500 m above sea level

11B Technical Data

Climatic requirements		
Comments	Environmental conditions	Application range
Pollutant concentration	SO ₂ : < 0.5 ppm; Rel. humidity < 60 %, H ₂ S: < 0.1 ppm; Rel. humidity < 60 %,	No condensation

Table 12-11 Data: Climatic Requirements

13 Index

24 V Power Supply.....	4-17	DS3.....	5-25
24 V supply	4-22	DS3 Adjustment Parameter.....	5-25
4-wire system	4-19	Effects of Interference	4-13
6-wire system	4-19	Environmental conditions	12-74
Accessories.....	11-66	Example software	2-4
Adjustment Digits	5-28	FB SICS_XX.....	8-51
Adjustment digits 0, 1, 2.....	5-27	FBCS_XX	8-50
Adjustment weight 0, 1, 2.....	5-27	Function	3-8
Area of Application.....	3-7	Further Support	1-3
Areas of Application	3-8	Gross process value.....	5-38
Assembly.....	4-11, 4-15	HW Config	8-50
Asynchronous messages.....	7-43	Info on module.....	5-35
Average Value Filter.....	5-31	Internal process values.....	5-36
Basic Knowledge.....	1-1	Internet Site	1-3
Benefits	3-6	LED.....	4-22
Cable shielding.....	4-14	LED color	4-21 , 7-48
Calibrating Applications.....	10-62	LED Display Elements.....	4-21
Calibration	10-62	LED message list.....	7-48
Calibration sticker.....	10-62	Limit Frequency	5-31
Call parameters.....	8-51	Limit Value	5-35
Certification (Calibration).....	10-62	Limit Value Parameters	5-33
Certification Stamp.....	10-62	Limit values.....	5-35
Certification, Calibration.....	10-62	Linearization	5-29
Characteristic Value	5-30	Load Cells.....	4-17
Climatic requirements	12-74	Low pass filter.....	5-26
Command groups.....	6-40, 6-42	Low Pass Filter	5-30
Command list	6-40	Maximum Weight for Weighing Range..	5-31
Commands.....	6-40	Message list.....	7-45, 7-46, 7-48
Commissioning, Preparation.....	4-22	Message paths	7-43
Configuration Package.....	2-4	Message types	7-43
Configuring.....	4-12	Messages	v, 1-2, 5-25, 7-43
Connection	4-15	Minimum Weight for Weighing Range..	5-31
Connection Areas.....	4-15	Net process value.....	5-38
Data and operating errors	7-45	Non-automatic weighing instruments .	10-62
Decimal Place	5-32	Numeral Step for Weighing Range.....	5-31
Diagnosis	7-43	Online operation	9-60
Diagnostic alarms.....	7-44	Operating error	5-38
DS 15	5-36	Operating messages	7-46
DS 26	5-36	PC connection	4-20
DS 30	5-37	Potential equalization conductor	4-17
DS 4	5-33	Power supply	4-22
DS 9	5-35	Preface	1-1

12B Index

Preparing for Operation.....	4-22	Standstill Time	5-31
Process Values	5-37	Structure	3-7
Product Overview.....	3-6	Structure to EMC Guidelines.....	4-12
Programming in SIMATIC STEP 7.....	8-49	Switch off weight, limit value 1.....	5-35
Regulations	5-33	Switch on weight, limit value 1.....	5-34
Scale Adjustment	3-9	Synchronous messages	7-43
Scale commands	6-40 , 6-41	System Integration in SIMATIC	3-8
Scale DB	8-50, 8-55	Tare	5-36
Scale functionality	3-6	Tare max. weight T-.....	5-33
Scale Name.....	5-31	Tare process value	5-38
Scale status.....	5-37	Technical Data.....	12-69
Scope of Delivery	2-4	Test values	12-71
Service and adjustment commands 6-40		Unit of Measurement	5-33
Setting the scale..... v, 1-2, 9-60		Vector DB	8-50
Shielding connection	4-16	Visual check	4-22
SIWATOOL CS	3-9, 3-10, 9-60	Weighing Functions	5-25
Standards	12-73	Wiring.....	4-15
Standstill monitoring.....	5-32	Zero Setting	5-33
Standstill Range	5-32		

14 Abbreviations

ADC	Analog-Digital Converter
ASCII	American Standard Code for Information Interchange
B	Gross weight
BG	Module
CPU	Central processing unit
DB	Data block
FB	Function block (S7)
FC	STEP7 function call
FM	Function module (for S7-300)
HMI	Human machine interface (SIMATIC Operator Panel)
HW	Hardware
LC	Load cell(s)
MPI	Multi-Point-Interface
NAWI	Non-automatic weighing instrument
NSW	Non-automatic weighing instrument
OD	Output Disable (S7)
OIML	Organisation Internationale de Metrologie Legale
OM	Object manager for STEP 7 objects
O&O	Operating and Observing
OP	Operator Panel (SIMATIC)
PC	Personal Computer
pT	Preset tare (predefined tare weight with manual taring)
PTB	Physikalisch Technische Bundesanstalt (certification authority for calibration of scales)
RAM	Random Access Memory
S7-300	Siemens Automation System for the mid-performance-range
S7-400	Siemens Automation System for the high-level performance range
SFC	System Function Call (S7)
STEP 7	Programming device software for SIMATIC S7
T	Tare weight
TP	Touch Panel (SIMATIC)
UDT	Universal Data Table (S7)
WRP	Write Protection